



47th Annual Meeting of the Japanese Society of Developmental Biologists

Co-sponsor: Asia-Pacific Developmental Biology Network



第47回日本発生生物学会

May 27 (Tue)–30 (Fri), 2014 WINC AICHI

Chair : Masahiko Hibi Bioscience and Biotechnology Center, Nagoya University

Program Book

Plenary Lecture

Prof. Alexander Schier (Harvard University)

Prof. Hans Clevers (Hubrecht Institute)

Workshops:

New Genome Technologies in Developmental Biology
Frontiers in Developmental Biology by Unique Approaches

Symposia:

Spain-Japan Joint Symposium : Morphogenesis and Organogenesis
Decoding and Handling the Stem Cell System
Cellular Dynamics in Early Mammalian Embryogenesis
Asia-Pacific Developmental Biology Network Symposium
Integrated Approaches Toward Deeper Understanding of Morphogenesis
New Era of Developmental Biology on Plants
Theoretical and Experimental Investigation of Morphogen Gradient Formation
A Contact Point Between Pluripotency and Germness
Making Conceptual Breakthroughs in Regenerative Biology and Medicine

<http://www.jsdb.jp/kaisai/jsdb2014/>

47th Annual Meeting for the Japanese Society of Developmental Biologists Program Book

May 27-30, 2014 Nagoya

Welcome to the 47th Annual meeting of JSDB in Nagoya !

Dear colleagues,

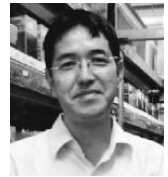

On behalf on the organizing committee, I would like to inform you that the 47th Annual Meeting for the Japanese Society of Developmental Biologists (JSDB) cosponsored by the Asia-Pacific Developmental Biology Network (APDBN) will be held in Nagoya from May 27th to 30th, 2014. Nagoya is located on the Pacific coast of central Honshu and can be conveniently accessed from within Japan and from abroad. The meeting venue, Winc Aichi, is situated close to Nagoya station (5-min walk) and downtown Nagoya. You can reach the venue from Chubu Centrair International Airport within an hour.

When creating the meeting program, we discussed the current trends and future directions of developmental biology and set up several symposiums that would attract the interest of many researchers and students. In this meeting, we also plan to have two special international symposiums: the APDBN symposium, and the Spanish Developmental Biology Society (SEBD)-JSDB exchange symposium. Furthermore, following the success of the 46th annual meeting in Matsue, we will continue to provide as many opportunities as possible for participants to give a talk, such as regular oral presentations or flash talks, in addition to poster presentations. The meeting will offer an international milieu for discussing your latest results in developmental biology. I hope that you will find the meeting program very attractive and exciting.

We look forward to seeing you in Nagoya in May.

Masahiko Hibi

Chairperson

Organizing Committee of the 47th Annual Meeting of the JSDB 2014

目次

ご挨拶	1
スポンサー	4
大会準備委員	4
会場への交通ご案内	5
会場内の見取り図	6
日程表	7
参加者へのご案内	11
DGD 編集委員会・JSDB 運営委員会	12
懇親会	12
ランチョン・セミナー	13
託児所	15
発表についてのご注意	16
iWAB (Web Abstract Book)	18
ポスター賞について	19
プログラム	
プレナリー・レクチャー	23
シンポジウム	24
ワークショップ	34
オーラルプレゼンテーション	37
フラッシュトーク	48
ポスター発表	59
テクニカルワークショップ (日本語)	79
若手ワークショップ (日本語)	80
市民公開講座 (日本語)	83
男女共同参画ワークショップ (日本語)	85
発表者氏名索引	87
展示企業一覧	
広告	
WEB 要旨集 閲覧方法	

Contents

Welcome Messages	1
Acknowledgement of Sponsorship	4
Organizing Committee	4
Access Guide to WINC AICHI	5
Floor Maps of WINC AICHI	6
Program at a Glance	7
General Information for Attendance	11
DGD Editorial Meeting & JSDB Board Meeting	12
Reception	12
Luncheon Seminars	13
Nursery	15
Instruction for Presentations	16
iWAB (Web Abstract Book)	18
Regarding Poster Awards	19
Scientific Programs	
Plenary Lectures	23
Symposia	24
Workshops	34
Oral Presentations	37
Flash Talks	48
Poster Sessions	59
Technical Workshop (in Japanese)	79
Satellite Workshops (in Japanese)	80
Public Lectures (in Japanese)	83
Forum by Gender-equal society (in Japanese)	85
Author Index	87
Exhibitor Index	
Advertisements	
How to view the online abstract book	

Acknowledgement of Sponsorship

The organizing committee of 47th Annual Meeting for JSDB gratefully acknowledges the generous financial support of the following:

Sponsors

The Federation of Pharmaceutical Manufacturers' Associations of JAPAN

The Naito Foundation

Suntory Foundation for Life Sciences

The Company of Biologists

ELSEVIER

Organizing Committee

Chairperson:	
Masahiko Hibi	Nagoya University
Members:	
Shinji Takada	Okazaki Institute for Integrative Biosciences
Hitoshi Sawa	National Institute of Genetics
Atsushi Kuroiwa	Nagoya University
Takaki Miyata	Nagoya University
Shosei Yoshida	National Institute for Basic Biology
Takashi Shimizu	Nagoya University
Hisashi Hashimoto	Nagoya University
Takayuki Suzuki	Nagoya University
Xinhua Lin	Chinese Academy of Sciences

Access Guide to WINC AICHI

WINC AICHI

4-4-38 Meieki, Nakamura-ku, Nagoya-city, Aichi 450-0002, Japan

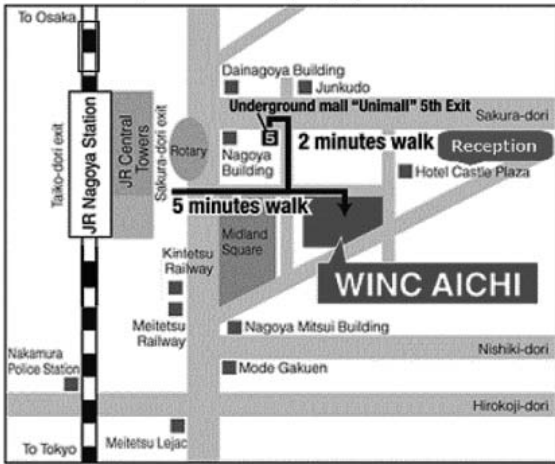

Guide with Pictures from JR Nagoya Station to WINC AICHI



① JR Nagoya Station
Sakura-Dori Side

② Crossing the ped-walk

③ Midland Square
North side : Straight ahead

④ WINC AICHI :
White Building on the right
(20m beyond the crossing)

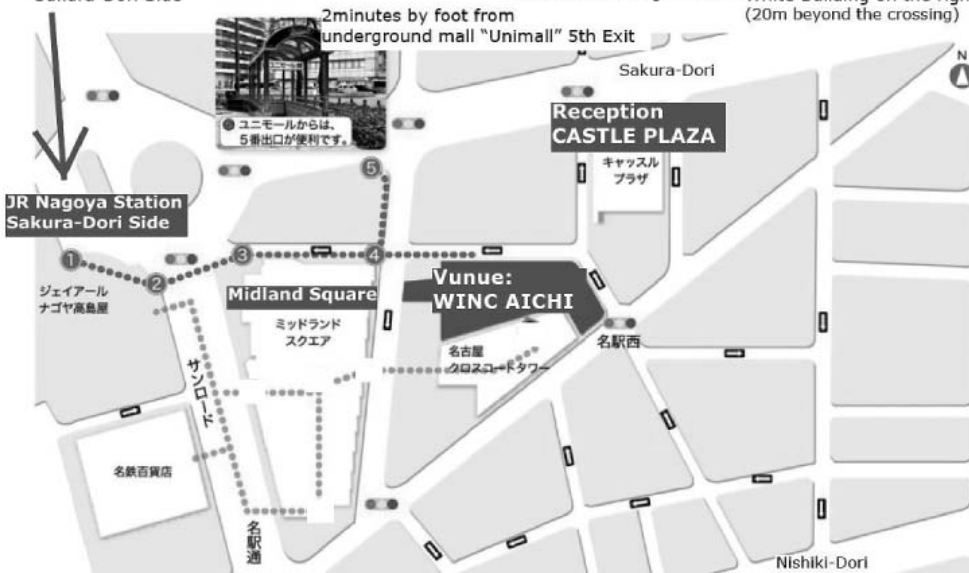

5minutes by foot from JR Nagoya Station.

2minutes by foot from underground mall “Unimall” 5th Exit.

To JR Nagoya Station:

Chubu Centrair International Airport → Meitetsu Line 28min. → Nagoya Station

Tokyo Station → Shinkansen Line 97min. → Nagoya Station

Shin-Osaka Station → Shinkansen Line 51min. → Nagoya Station

Floor Maps of WINC AICHI

6F

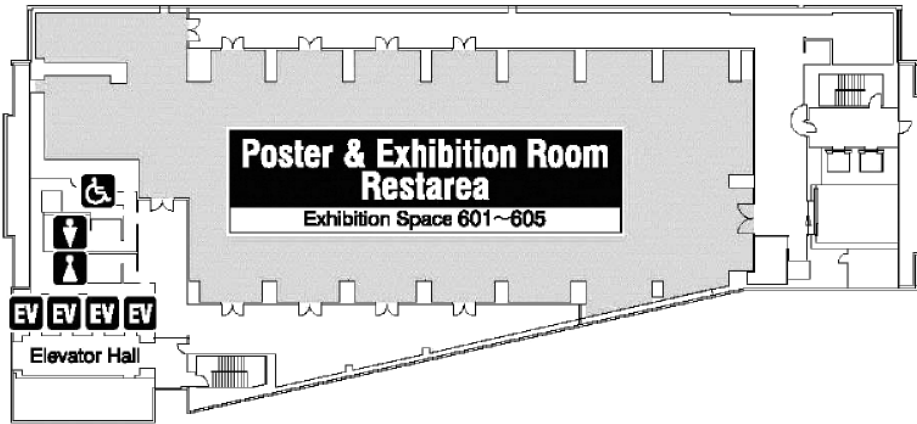

5F

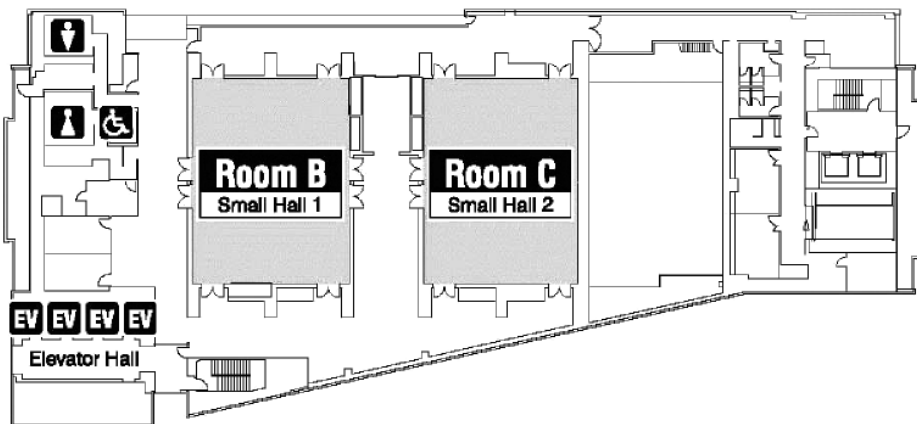

2F

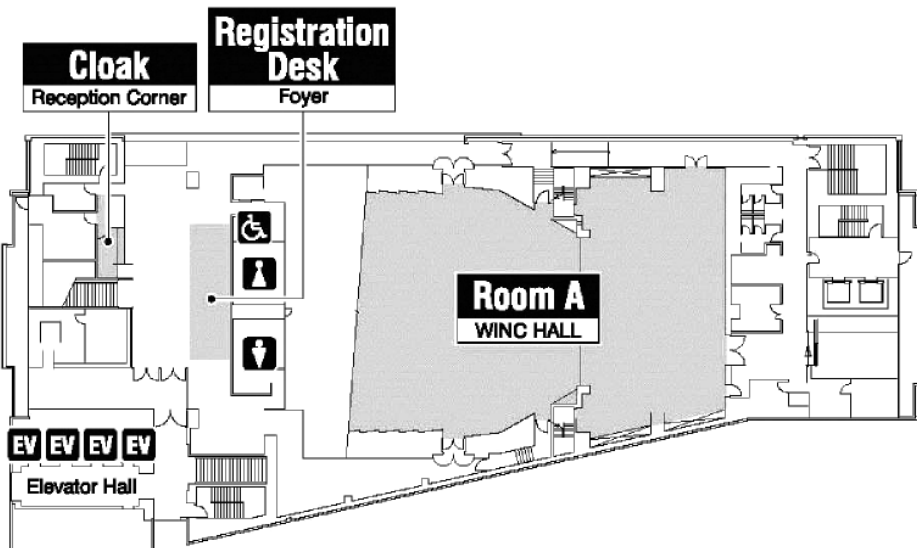

Program at a Glance

Day 0 (May 27(Tue))

	11:00 ~ 15:00	13:00 ~ 16:00	16:30 ~ 19:30
Room A (2F)		Technical Workshop (in Japanese) Fundamentals of Quantitative Image Analysis	Oral presentation 1 Neural Development and Behavior / Technology, Theoretical Approach, Systems Biology
Room B (5F)		Satellite Workshop (in Japanese) Morphogenesis and Signaling	Oral presentation 2 Stem Cells and Regeneration
Room C (5F)		Satellite Workshop (in Japanese) Stem Cells and Neural Development	Oral presentation 3 Signaling in Development
Room D	DGD Editorial Meeting & JSDB Board Meeting		

Day 1 (May 28(Wed))

	9:00 ~ 11:30	12:00 ~ 13:00	13:30 ~ 14:30	14:30 ~ 16:00	16:00 ~ 19:00
Room A (2F)	Symposium 1 Spain-Japan Joint Symposium “Morphogenesis and Organogenesis”	Luncheon (Olympus Corporation) (in Japanese)	Flash Talk 1 Early Embryogenesis / Evolution and Development		Workshops 1 New Genome Technologies in Developmental Biology
Room B (5F)	Symposium 2 Decoding and Handling the Stem Cell System		Flash Talk 2 Morphogenesis		Oral presentation 4 Early Embryogenesis / Evolution and Development
Room C (5F)	Symposium 3 Cellular Dynamics in Early Mammalian Embryogenesis		Flash Talk 3 Neural Development and Behavior		Oral presentation 5 Morphogenesis
Poster Room (6F)	Posters			Discussion time 1	
	Exhibition (Equipment & books)				

Day 2 (May 29(Thu))

	9:00 ~ 11:30	11:45 ~ 13:00	13:30 ~ 14:30	14:30 ~ 16:00	16:00 ~ 19:00	19:30 ~
Room A (2F)	Plenary Lectures	General assembly (in Japanese)	Flash Talk 4 Signaling in Development / Reproduction and Gametogenesis / Cell Biology		Workshops 2 Frontiers in Developmental Biology by Unique Approaches	
Room B (5F)			Flash Talk 5 Stem Cells and Regeneration		Oral presentation 6 Gene Expression and Epigenetics / Reproduction and Gametogenesis	
Room C (5F)			Flash Talk 6 Organogenesis / Regulation of Gene Expression / Neural Development and Behavior		Oral presentation 7 Cell Biology / Organogenesis	
Poster Room (6F)	Posters			Discussion time 2		
Castle Plaza	Exhibition (Equipment & books)					Reception

Day 3 (May 30(Fri))

	9:00 ~ 11:30	12:00 ~ 13:00	13:30 ~ 16:00
Room A	<p>Symposium 4 APDBN Symposium: Mechanisms of Morphogen signaling in pattern formation, organogenesis and homeostasis</p>		<p>Symposium 7 Theoretical and Experimental Investigation of Morphogen Gradient Formation</p>
Room B	<p>Symposium 5 Integrated Approaches Toward Deeper Understanding of Morphogenesis</p>	Gender-equal society	<p>Symposium 8 A Contact Point Between Pluripotency and Germness</p>
Room C	<p>Symposium 6 New Era of Developmental Biology on Plants</p>	Grants-in-Aid for Scientific Research <KAKENHI> Seminar	<p>Symposium 9 Making Conceptual Breakthroughs in Regenerative Biology and Medicine</p>
Poster Room	Exhibition (Equipment & books)		

General Information for Attendance

Venue

WINC AICHI

4-4-38 Meieki, Nakamura-ku, Nagoya-city, Aichi 450-0002, Japan

Phone: +81-52-571-6131 Fax: +81-52-571-6132

URL: <http://www.winc-aichi.jp/> (in Japanese)

Official Language

English will be the official conference language, and no simultaneous translation will be provided. The Satellite Workshops and Technical workshop will be held in Japanese.

Registrations

Advanced Registration is no longer available. Please register at the conference venue. (On-site registration is available throughout the conference period.)

Registration Fee (On-site) (JPY)

General JSDB/ISDB/APDBN members: ¥10,000 (early ¥8,000)

Student JSDB/ISDB/APDBN members: ¥5,000 (early ¥4,000)

General Non-members: ¥10,000 (early ¥9,000)

Student Non-members: ¥6,000 (early ¥5,000)

General Non-members (Residing overseas): ¥2,000 (early ¥0)

Student Non-members (Residing overseas): ¥1,000 (early ¥0)

*Registration includes access to all scientific sessions and exhibits.

*Students should provide the name and affiliation of their supervisor.

JSDB General Assembly

May 29 (Thursday), 11:45-13:00, Room A

Payment

All payment must be made in Japanese yen, by credit card or by bank draft, payable to “The 47th Annual Meeting of the JSDB”. Please send payment with the completed registration form to the secretariat. **No** checks or money orders will be accepted. All bank charges are to be borne by the remitter.

Name Tags

Name tags will be sent to advance registrants, or will be provided at the time of registration. Participants are requested to wear their name tags at all times during the conference.

Lunch

May 29 (Thu) : Lunch boxes available (¥1,000).

May 28 (Wed) & May 30 (Fri): At the luncheon seminar, a limited number of free lunch boxes will be provided by sponsor.

Refreshments and Internet Access

Free Wi-Fi is available at the Poster Room, 6F.

DGD Editorial Meeting & JSDB Board Meeting

May 27 (Tue) 11:00-15:00, WINC AICHI Room D

Reception

May 29 (Thu) 19:30-21:30

Castle Plaza

4-3-25 Meieki, Nakamura-ku, Nagoya-city, Aichi, 450-0002, Japan

Phone: +81-52-582-2121 Fax: +81-52-582-8666

URL: <http://www.castle.co.jp/plaza/>

Reception fee (On-site) (JPY)

General JSDB members: ¥ 8,000 (early ¥7,000)

Student JSDB members: ¥4,000 (early ¥3,000)

General non-members: ¥ 8,000 (early ¥7,000)

Student non-members: ¥4,000 (early ¥3,000)

General Non-members (Residing overseas): ¥8,000 (early ¥7,000)

Student Non-members (Residing overseas): ¥4,000 (early ¥3,000)

Cloakroom

Cloakroom is available for your luggage. Please note that valuables and computers cannot be accepted.

We are not responsible for any damage or loss at the cloakroom.

Open Hour: 8:30-19:30 (Closed at 17:00 on May 30(Fri.))

Location: 2F

Luncheon Seminar (in Japanese)

オリンパス株式会社 ランチョンセミナー

=Luncheon Seminar by Olympus Corporation. =

May 28 (Mon) 12:00-13:00, Room A

独立行政法人日本学術振興会 ランチョンセミナー

=Luncheon Seminar by Japan Society for the Promotion of Science=

May 30 (Fri) 12:00-13:00 Room C

オリンパス株式会社 ランチョンセミナー
=Luncheon Seminar by **Olympus Corporation.**=
May 28 (Wed) 12:00-13:00, Room A

タイトル: 「レーザー顕微鏡を用いた脳のコネクトミクス解析と機能イメージング」

講演者: 伊藤 啓先生 (東京大学 分子細胞生物学研究所 脳神経回路研究分野)

新製品のご紹介

「多光子励起レーザー走査型顕微鏡 FVMPE-RS」

ミリ秒単位の速い生体反応を捉える高速イメージング。
深部でもエネルギー密度の高い理想的なスポットで
励起ができ、散乱した蛍光も効率良く検出する
高 S/N なイメージング。深部での多波長同時イメー
ジング。マルチポイントの光刺激やパッチクランプ
のデータとの同期。

オリンパス FLUOVIEW FVMPE-RS が次世代の
多光子観察のために目指したもの、それは高速、
深部、多色、光刺激。一切の妥協を許さない研究者
のために。

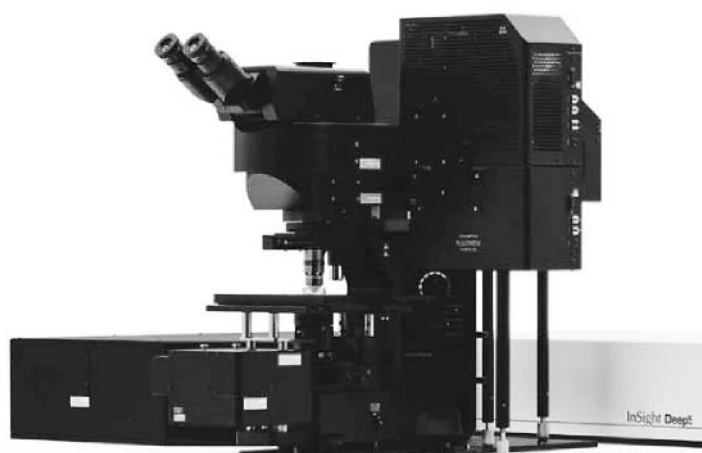

Luncheon Seminar ランチョンセミナー
5月30日(金) 12:00～13:00 会場: Room C

科学研究費補助金セミナー
Grants-in-Aid for Scientific Research <KAKENHI> Seminar

1. 「科研費」の最近の動向

Outline of Grants-in-Aid for Scientific Research (KAKENHI) and its Trends

日本学術振興会 研究助成第一課長 大鷲正和

日本学術振興会から、科研費の配分機関として、制度の概要、応募から審査、決定までの流れ、補助金、助成金の執行と適切な管理、不正防止に関すること、また、成果の公開、科研費の普及啓発などについて、ご説明します。

2. 日本学術振興会の諸事業における学術システム研究センターの役割

Research Center for Science Systems and the Roles of Program Officers

日本学術振興会 学術システム研究センター専門調査役 樋口和憲

日本学術振興会には、公平・公正で透明性の高い審査・評価の実施のために、学術システム研究センターが設置され、研究機関に籍を置く第一線の研究者が、科研費等の審査委員候補者の選考、審査結果の検証、分科細目表の見直しや制度の改善など、幅広い業務に参画しています。学術的な見地から、最新の学術動向や現場の声を事業運営に反映させるための様々な活動について、ご紹介します。

第 47 回日本発牛生物学会年会 保育室のご案内

保育室の利用を希望される方は、以下の規定を御確認の上、所定の手続き方法に従って日本語でお申込ください。なお保育スタッフは英語を話せません。

託児時間	5月28日(水) 8:30～19:30 5月29日(木) 8:30～19:30 5月30日(金) 8:30～16:30 (*原則としてお子様の昼食は、保護者が一緒におとりください。)
対象年齢	生後3ヶ月から12歳まで(大会参加者のお子様に限る)(首のすわっているお子様～)
託児場所	※セキュリティ確保の為、お申込者のみにご案内致します。
託児形態	ベビーシッター会社へ保育スタッフを依頼します。
委託先	株式会社ケアメイトサービス
託児料	500円/時間/お子さま1名(1時間未満は切上げ) 保育料のお支払いは、お子様をお預けの際にお願いします。 *申込みにより保育スタッフを依頼しますので、当日のキャンセルや、実際の利用時間が申込時間よりも短くなった場合は、申込時の保育料のお支払いをお願いします。また、利用時間をやむを得ず延長された場合には、延長分のお支払いをお願いします。
申込み先	「利用規約(PDF95KB)」を確認のうえ、必要事項を記入した「申込書(PDF84KB)」をFAXまたはEメールにてお申し込みください。 後日、詳細を記載しました「受領確認書」をお申し込み頂いた方法で返信します。お申し込み後一週間以内に受領確認書が届かない場合には、下記の「申し込み先・お問い合わせ先」まで必ずお問い合わせください。 ※ 保育室の場所は、受領確認書に記載させていただきます。 ※ 電話での受付は 078-306-3072 (平日 9:00～17:00) ■申し込み先・お問い合わせ先 日本発牛生物学会 事務局 担当: 桃津 FAX: 078-306-3072 E-mail: jsdb2014@jsdb.jp TEL: 078-306-3072 (平日 9:00～17:00)
申込締切	<u>2014年5月9日(金) 17時00分</u> ただし、定員になり次第締め切らせて頂きますのでお早めにお申込み下さい。
不測の事故に対応するために、株式会社ケアメイトサービスが保険に加入しており、保険適用範囲で補償いたします。また第47回日本発牛生物学会年会は、事故の責任は負わないことを申し添えます。	

Instruction for Presentations

大会発表についてのご注意

Oral presentation

1. Presentation time

Oral presentation: **12 min** for presentation and **3 min** for discussion.

Satellite Workshop: **12 min** for presentation and **3 min** for discussion.

2. Computer for oral presentation

Presentation shall be given with your own laptop.

Please do not forget to bring your laptop.

- Make sure to bring any necessary electrical adaptors and connectors for your computer.
- The meeting venue will provide a Mini D-sub15 pin cable for connecting to PC switchers. Macintosh and certain kinds of Windows computers require an appropriate connector to fit a Mini D-sub15 pin plug.
- Electric power in Nagoya is provided at 100 V, 60 Hz.

3. Presentation registration

Please come to your session room at **20 min** prior to the beginning of the talk and connect your PC to a PC switcher.

Flash Talk

1. Regarding flash talk

In your Flash talk, please give a simple summary of what your poster is about. Please avoid presenting specific data.

2. Presentation time

Flash talks are **3 min** in length. There is no Q & A. When three minutes are up, the slides will automatically be removed from the screen. We would appreciate your cooperation in keeping to the allotted time to ensure that the session runs smoothly.

3. Presentation data

Please submit your presentation data in advance between Monday, May 19 and Sunday, May 25.

Submit to: jsdb2014@jsdb.jp

- **Please make your presentation using PowerPoint (in Windows or Mac; Keynote cannot be used).**
- First slide should be the title slide which includes your name, affiliation, presentation title, and subject number), and your presentation should be no more than three slides long (including the title slide).
- File size should be less than 5 MB.
- PowerPoint file name is “Subject number (Presenter name)”. Example: FT01-01 (Taro Nihon)
- Please do not lock your file with a password.

*The presentation data received for the Flash Talk will only be used on the day of the presentation. We will not upload it to the web or publish it in other media. The data will be deleted after the session.

****If presentation data is not received by the deadline, your slot will be canceled.**

4. Presentation method

A computer will be prepared for the presentations. Presentation data submitted in advance will be pre-installed in the computer prepared for the presentations. You will not be able to use your own computers for the presentation. Please submit your presentation data by the deadline.

5. Presenter registration

Present yourself at the reception desk for presenters located in the venue for the Flash Talks at least **20 min** before the session begins.

Poster Presentations

Poster board size: 900 mm (width) × 2,100 mm (height)

- ✧ Please leave a 200 mm × 200 mm blank space at the top left corner for the organizing committee to indicate your poster number.
- ✧ Please stay (or stand) in the vicinity of your poster for explanation during your assigned discussion time. Be sure that every poster presenter is assigned to explain his/her poster on both Day 1 (May 28) and Day 2 (May 29).
- ✧ Best Presentation Awards will be given for several student presenters. Award winners will be selected using the web voting system by capable participants of the meeting, and will be announced after the meeting.

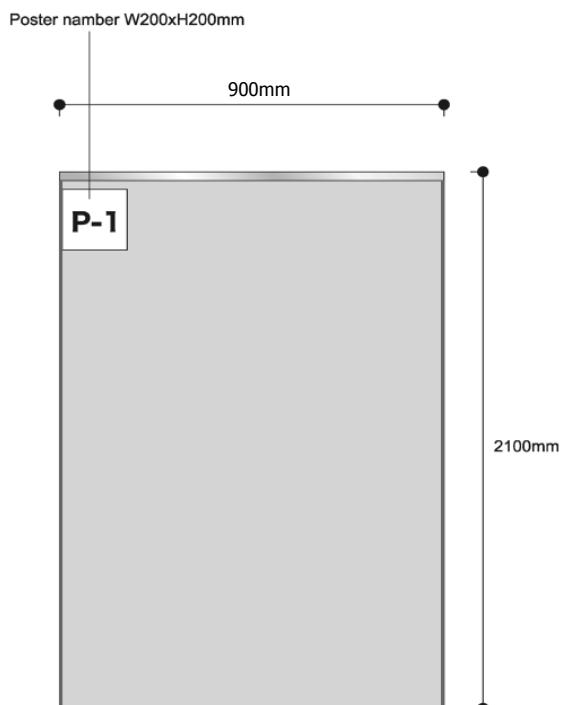

Mounting:	9:00-13:00 on 28 May
Day1(May 28)	14:30-16:00 on 28 May
Discussion:	14:30-15:15 for odd number posters 15:15-16:00 for even number posters
Day2(May 29)	14:30-16:00 on 29 May
Discussion:	14:30-15:15 for A number posters 15:15-16:00 for B number posters
Removal:	9:00-13:30 on 30 May

Chairpersons

All chairpersons are required to come to their assigned session rooms at least **20 min** prior to the start of the session they will chair.

iWAB (Web Abstract Book)

The iWAB system is available again this year, with new, more powerful features.



PC in the office Smartphone at the venue

iWAB is available on PCs, smartphones and tablets, and even on feature phones!

Prepare on your office PC with a comfortable large-size screen. Use our fast and powerful search and recommendation capabilities. “Like” and “schedule” the presentations that interest you.

At the venue, use your smartphone. All your “likes” and “schedules” are always with you to assist efficient use of your time. We also send notifications for upcoming presentations.

Lots to “Like”

Use the “Like” feature in iWAB to encourage and show appreciation for other scientist’s work.

iWAB allows authors to see who “liked” their work and what work they are doing. You can see what presentations they will give at this conference. This could lead to a new collaboration.

We **respect your privacy**, hence “Likes” in iWAB are only visible to authors. This year, we also have “**secret likes**” which are invisible to even authors.



Communicate more

The face-to-face discussions and communications are what makes conferences uniquely fun.

iWAB has a “Yoruzemi” feature which helps you organize and attend parties. It also has a private messages feature to allow you to directly communicate with other participants.



Regarding Poster Awards

Eligible participants:

Students or young research scientists (received Ph.D. within last five years) who wish to be considered for the poster awards

Eligible Voters:

Organizing committee members, DGD editorial committee members, and any PI who would like to vote.

How to vote:

Voting will be carried out through the iWAB system. Eligible voters will see an icon for “Poster Award Voting” appear on their iWAB screen. Clicking on the icon will allow the individual to vote.

- Number of votes possible per eligible voter will also appear on iWAB.

Award ceremony:

The award ceremony will be held during the reception held in the Castle Plaza on May 29 (tentative).

Scientific Programs

Plenary Lectures

May 29 (Thu) 9:00-11:30 Room A

Chairperson: Hiroyuki Takeda (Univ. of Tokyo)

PL-01 09:00-10:15 The Molecular Control of Embryogenesis: Insights from Zebrafish

○Alexander Schier (Harvard)



Chairperson: Shosei Yoshida (NIBB)

PL-02 10:15-11:30 Lgr5 Stem Cells in Self-renewal and Cancer

○Hans Clevers (Hubrecht Institute, Royal Netherlands Academy of Arts and Sciences & University Medical Centre Utrecht)



Symposia

Symposium 1: Spain-Japan Joint Symposium: Morphogenesis and Organogenesis

May 28 (Wed) 9:00 ~ 11:40 Room A

Organizers: Yoshiko Takahashi (Kyoto Univ.)

Angela Nieto (Instituto de Neurociencias de Alicante)

This symposium is aimed at promoting relationships between Spanish Society of Developmental Biology and JSDB. From the Spanish side, two senior and two junior scientists will join, and a couple of Japanese junior scientists will also present their researches. The topics we hear in this symposium will cover morphogenesis, organogenesis, and cancer biology. This symposium provides a precious opportunity to both societies to appreciate developmental biology going on in the two countries.

- S01-01** 09:00-09:30 Reversibility of Epithelial-Mesenchymal Transition in development and disease
○Angela Nieto (Instituto de Neurociencias CSIC-UMH)
- S01-02** 09:30-09:50 How to convert cardiomyocyte into smooth muscle; Lessons from fish heart evolution
心筋か平滑筋か；真骨魚類の進化から明らかとなった新規細胞運命決定メカニズム
○Yuuta Moriyama, Jun Takeuchi, Kazuko Koshiba-Takeuchi (Division of Cardiovascular Regeneration, IMCB)
- S01-03** 09:50-10:10 Can we dedifferentiate cells in vivo?
○Maria Abad¹, Lluc Mosteiro¹, Cristina Pantoja¹, Marta Cañamero¹, Teresa Rayón², Inmaculada Ors², Osvaldo Graña¹, Diego Megías¹, Orlando Domínguez¹, Dolores Martínez¹, Miguel Manzanares², Sagrario Ortega¹, Manuel Serrano¹ (CNIO¹, CNIC²)
- S01-04** 10:10-10:30 Tubulogenesis using Wolffian duct as a model: Tubule elongation and cell epithelialization are coordinated by FGF signals
ウォルフ管をモデルとした上皮管形成機構の解析：FGF シグナルは管伸長と上皮管腔化の進行をコーディネートする
○Yuji Atsuta, Yoshiko Takahashi (Grad. Sch. of Sci., Kyoto Univ.)
- S01-05** 10:30-10:50 Spatially restricted distribution of Hedgehog in exovesicles moving along cytonemes
○Ana Gradilla¹, Esperanza Gonzalez², Marcus Bischoff³, Juan Falcon², Isabel Guerrero¹ (CBMSO¹, BioGUNE², University of St. Andrews, UK³)
- S01-06** 10:50-11:10 The maintenance of epithelial architecture by controlling mitotic spindle orientation
細胞分裂軸の制御による上皮構造の維持
○Yuichiro Nakajima, Matthew Gibson (Stowers Institute)
- S01-07** 11:10-11:40 Cell Competition regulation of tissue homeostasis in Mammals
○Miguel Torres, Cristina Clavería, Cristina Villa del Campo, Giovanna Giovino, Rocío Sierra (CNIC, Spain, Madrid)

Symposium 2: Decoding and Handling the Stem Cell System

May 28 (Wed) 9:00 ~ 11:30 Room B
Organizers: Atsushi Suzuki (Kyusyu Univ.)
Mitsuru Morimoto (RIKEN CDB)

Stem cell systems may have developed to be suitable for the maintenance of tissues and organs in the process of evolution. That is why each stem cell system is individualistic and has distinctive features involved in both the function and the regulation of stem cells. Scientists are challenging to dissect the molecular nature of such diverging stem cell systems and apply the knowledge obtained from the basic research to the development of therapeutic strategies for human diseases. In this symposium, we invite young and energetic scientists who are passionately studying to understand and trying to manipulate the stem cell system. These speakers will present the exciting new findings and discuss the future directions in this field.

- S02-01** 09:00-09:25 Bidirectional interactions between epidermal stem cells and their niche in skin morphogenesis and regeneration
皮膚形態形成と再生における表皮幹細胞とそのニッチとの双方向性相互作用
○Hironobu Fujiwara (RIKEN CDB)
- S02-02** 09:25-09:50 Notch signaling contributes to population and regional regulations of the airway epithelial stem and differentiated cells.
Notch シグナルは気道上皮の幹細胞および分化細胞の数的、空間的バランス制御に関わっている
○Mitsuru Morimoto (Lab. for Lung Dev., RIKEN CDB)
- S02-03** 09:50-10:15 Regulation of stem cell properties in liver development
肝発生における幹細胞の特性制御
○Atsushi Suzuki^{1,2} (Div. of Organo. & Regene., Med. Inst. of Bioreg., Kyushu Univ.¹, CREST, JST²)
- S02-04** 10:15-10:40 The Self-renewing Mechanism of Intestinal Stem Cell: Niche and Cancer
○Toshiro Sato, Yuki Ohta, Ai Takano, Shoichi Date, Mami Matano, Mariko Shimokawa (Department of Gastroenterology, Keio University School of Medicine)
- S02-05** 10:40-11:05 Vascularized and functional human liver from an iPSC-derived organ bud transplant
○Takanori Takebe^{1,2} (Department of Regenerative Medicine, Yokohama City University¹, PRESTO, Japan Science and Technology Agency²)
- S02-06** 11:05-11:30 Chimera formation with non-chimera forming cells
○Hideki Masaki (Center for Stem Cell Biology and Regenerative Medicine, The Institute of Medical Science, The University of Tokyo)

Symposium 3: Cellular Dynamics in Early Mammalian Embryogenesis

May 28 (Wed) 9:00 ~ 11:30 Room C

Organizers: Hiroshi Sasaki (Kumamoto Univ.)

Toshihiko Fujimori (NIBB)

Understanding of early developmental process of mammals has been challenging. Recent integration of molecular genetics, cell biology, live cell imaging and quantitative biology into developmental biology of mouse embryogenesis provided a wide variety of information regarding cellular and molecular behaviors in developing embryos. The scope of this symposium is to share such cutting-edge researches and discuss future perspectives in the field.

- S03-01** 09:00-09:25 Modulation of early mammalian brain development through local apoptotic elimination of morphogen-producing cells
局所的なアポトーシスによる哺乳類脳初期発生の調節
○Yoshifumi Yamaguchi^{1,2}, Keiko Nonomura¹, Naomi Shinotsuka¹, Misato Hamachi¹, Yudai Matsumoto¹, Masayuki Miura^{1,3} (Dept. Genet. Pharma. The Univ. of Tokyo, Japan¹, PRESTO, JST, Japan², CREST, JST, Japan³)
- S03-02** 09:25-09:55 Uterine Rbpj is required for embryo-uterine orientation and decidual remodeling via Notch pathway-independent and -dependent mechanisms
Shuang Zhang, ○Haibin Wang (State Key Laboratory of Reproductive Biology, Institute of Zoology, Chinese Academy of Sciences)
- S03-03** 09:55-10:25 Endosome dynamics and its implication in patterning of mouse early embryo
マウス初期胚のシグナル制御とエンドサイトーシス
○Yoh Wada (ISIR, Osaka Univ.)
- S03-04** 10:25-10:55 Guts & gastrulation: cell dynamics and the morphogenesis of the early mouse embryo
○Kat Hadjantonakis, Manuel Viotti, Sonja Nowotschin (Memorial Sloan Kettering Cancer Center, New York)
- S03-05** 10:55-11:10 Quantification of embryo quality by live-cell imaging
○Kazuo Yamagata (Research Institute for Microbial Diseases, Osaka University)
- S03-06** 11:10-11:27 Dynamics of mammalian preimplantation embryos reconstructed from 4D bio-imaging data
バイオイメージデータからの哺乳類着床前胚の発生ダイナミクスの再構成
○Tetsuya Kobayashi¹, Khayrul Bashar¹, Mitsunori Ozeki², Akira Funahashi², Kazuo Yamagata³ (ISS, Univ. Tokyo¹, Keio Univ.², Osaka Univ.³)
- 11:27-11:30 Closing

Symposium 4: APDBN Symposium: Mechanisms of Morphogen Signaling in Pattern Formation, Organogenesis and Homeostasis

May 30 (Fri) 9:00 ~ 11:30 Room A

Organizers: Xin-hua Lin (Institute of Zoology, Chinese Academy of Sciences)
Philip Ingham (IMCB, Singapore)

Morphogens (including Wnt, Hh, Bmp, and Nodal) are essential intercellular signaling molecules which form concentration gradients and elicit their activities required for embryonic patterning and organogenesis during development. Recent studies have also shown critical roles of morphogens in homeostasis and regeneration. In this symposium, scientists from Asia-Pacific Developmental Biology Network (APDBN) will talk about their recent progresses on the mechanisms of morphogen signaling and the functions of morphogens during development and homeostasis.

Co-organized by Asia-Pacific Developmental Network (APDBN)

- S04-01** 09:00-09:25 Intracellular transduction of Hedgehog activity in the Zebrafish
Zhonghua Zhao², Ashish Maurya², Jin Ben², Raymond Lee², Jayantha Gunaratne², Stone Elworthy³, Freek van Eeden³, [○]Philip Ingham^{1,2} (LKCMedicine, Imperial College-NTU¹, IMCB, Singapore², MRC CDBG, University of Sheffield³)
- S04-02** 09:25-09:50 Decoding Ci: from partial degradation to inhibition
Zhao Zhang, Xiangdong Lv, Jing Feng, [○]Yun Zhao (SIBCB, CAS)
- S04-03** 09:50-10:15 Role of motile and immotile cilia in left-right patterning
左右の決定における繊毛の役割
[○]Hiroshi Hamada (Osaka University)
- S04-04** 10:15-10:40 Essential roles of BMP and Hh morphogens in regulating gut stem cell activity and tissue homeostasis
Zhouhua Li¹, Yan Zhang¹, Yueqin Guo¹, Lili Han¹, Lai Shi¹, Huang Xudong², [○]Xinhua Lin^{1,3} (Institute of Zoology, CAS, Beijing, China¹, School of Optometry and Ophthalmology and Eye Hospital, Wenzhou Medical University, Wenzhou 325000, China², Division of Developmental Biology, Cincinnati Children's Hospital Medical Center, Cincinnati, OH 45229, USA³)
- S04-05** 10:40-11:05 EpCAM Is an Endoderm-Specific Wnt Derepressor that Licenses Liver Development
Huiqiang Lu, Jun Ma, Yun Yang, Wenchao Shi, [○]Lingfei Luo (School of Life Sciences, Southwest Univ.)
- S04-06** 11:05-11:30 Lineage extension chondrocytes and the ontogeny of bone cells.
[○]Kathryn SE Cheah¹, Liu Yang¹, Kwok Yeung Tsang¹, Hoi Ching Tang¹, Horace Tsang¹, Yingzi Yang², Danny Chan¹ (Dept. Biochemistry, University of Hong Kong, Hong Kong¹, National Human Genome Research Institute, National Institutes of Health²)

Symposium 5: Integrated Approaches Toward Deeper Understanding of Morphogenesis

May 30 (Fri) 9:00 ~ 11:30 Room B

Organizers: Koichi Nishiyama (Univ. of Tokyo)

Shinji Ihara (NIG)

Living organisms are built from assemblies of cells that have intrinsic variation in shape and motility in part due to thermal fluctuation of biological macromolecules. In order to understand the mechanism of how orderly shape of organisms is specified reproducibly from random assortment of cells and molecules, investigation not only from biological standpoint, but also from physics and theoretical biology would be effective. It is anticipated that such integrated approaches would eventually lead to reconstitution of biological processes and morphogenesis with defined mechanisms. In this symposium, researchers tackling this challenge with variety of approaches will present their latest works.

09:00-09:05 Short Introduction

- S05-01** 09:05-09:33 Differential modification of apical-basal polarity as a novel mechanism for the initiation of epithelial folding
○Yu-Chiun Wang (RIKEN CDB)
- S05-02** 09:33-10:01 Hemodynamic control of vascular remodeling through endothelial cell mechanotransduction
内皮細胞の血流応答を介した血管リモデリング
○Kimiko Yamamoto¹, Joji Ando² (System Physiol., Dep. of Biomed. Eng., Grad. Sch. of Med., Univ. of Tokyo¹, Biomed. Eng., Sch. of Med., Dokkyo Med. Univ.²)
- S05-03** 10:01-10:29 Intertwined regulatory circuits initiating 2-dimensional patterns of stomata in plant epidermis
○Keiko U. Torii (Howard Hughes Medical Institute and Department of Biology, University of Washington)
- S05-04** 10:29-10:57 Rich types of repulsive behavior to quinine in *Physarum plasmodium*
粘菌変形体のキニーネに対する忌避行動の多様性
Itsuki Kunita¹, ○Toshiyuki Nakagaki¹, Kei-ichi Ueda², Yasumasa Nishiura³ (RIES, Hokkaido Univ.¹, Dep. Math., Toyama Univ.², WPI, Tohoku Univ.³)
- S05-05** 10:57-11:25 Cell type diversification through reconstituted lateral inhibition
側方抑制によって細胞集団が多様化するしくみの再構成
○Miki Ebisuya (RIKEN CDB)

Symposium 6: New Era of Developmental Biology on Plants

May 30 (Fri) 9:00 ~ 11:30 Room C

Organizers: Hirokazu Tsukaya (Univ. of Tokyo)

Takashi Araki (Kyoto Univ.)

The fundamental mechanisms of plant development are not yet fully understood. We aim to revolutionize the field of developmental biology through new concepts and a research style that is expected to produce breakthroughs for the understanding of fundamental logics of plant development. Here we introduce our challenges that try to create a new era of discovering novel developmental concepts: logics.

Co-organized by: “Multidimensional Exploration of Logics of Plant Development”, “The Plant Cell Wall as Information Processing System”

09:00-09:05 Opening

S06-01 09:05-09:30 Logics of Leaf Development: How is the meristematic zone positioning determined?

葉の発生ロジック：その分裂組織の位置決めに関する謎

○Hirokazu Tsukaya (Univ. Tokyo)

S06-02 09:30-09:55 Comprehensive genetic analysis of CLV3 downstream pathway in Arabidopsis.

シロイヌナズナの幹細胞活性を制御する CLV3 ペプチドホルモンのシグナル伝達機構の解析

○Shinichiro Sawa (Kumamoto Univ.)

S06-03 09:55-10:20 Developmental Signaling in the Arabidopsis Root Pattern Formation

シロイヌナズナの根のパターン形成における発生シグナル伝達

○Keiji Nakajima^{1,2} (Grad. Sch. Biol. Sci., NAIST¹, PRESTO, JST²)

S06-04 10:20-10:45 Genetic regulation of flower and inflorescence development in rice

イネの花や花序の発生を制御する遺伝的機構

○Hiroyuki Hirano (Dept. Biological Science, Univ. Tokyo)

S06-05 10:45-11:10 Exploring the plant reproductive processes using Arabidopsis and Marchantia

シロイヌナズナとゼニゴケを用いた有性生殖過程の解析

○Takashi Araki (Grad. Sch. Biostudies, Kyoto Univ.)

11:10-11:30 General Discussion

Symposium 7: Theoretical and Experimental Investigation of Morphogen Gradient Formation

May 30 (Fri) 13:30-16:00 Room A

Organizers: Shinji Takada (OIIB)

Isao Matsuo (Osaka Medical Center)

Morphogens have been suggested to provide the positional information to pattern developing tissues in a concentration-dependent manner. During the last two to three decades, molecular genetics has succeeded to identify extracellular signaling molecules that may act as morphogens. Now, we are on a stage where we can expand these excellent fruits of molecular biology by introducing new approaches, such as live imaging techniques and theoretical studies, to uncover dynamics of morphogen diffusion and mechanism by which morphogenic field is established and maintained. This symposium will provide excellent examples of morphogen studies in this new era.

Co-organized by : From Molecules and Cells to Organs: Trans-Hierarchical Logic for Higher-Order Pattern and Structures Analysis and Synthesis of Multidimensional Immune Organ Network

13:30-13:35 Introduction

- S07-01** 13:35-14:05 Variability and robustness in early embryonic patterning
○Benny Shilo, Neta Degani, Inna Averbukh, Michal Haskel-Ittah, Neta Strasser, Eyal Schejter, Naama Barkai (WIS)
- S07-02** 14:05-14:27 Interplay between morphogen and cellular competence in the neural tube pattern formation
○Noriaki Sasai, Eva Kutejova, James Briscoe (MRC National Institute for Medical Research)
- S07-03** 14:27-14:49 The role of heparan sulfate proteoglycans in *Drosophila* germline stem cell niche.
ショウジョウバエ生殖幹細胞ニッチにおけるヘパラン硫酸プロテオグリカンの役割
○Yoshiki Hayashi^{1,2}, Arisa Sugiyama^{1,2}, Satoru Kobayashi^{1,2} (Okazaki Institute for Integrative Bioscience, NIBB¹, SOKENDAI²)
- S07-04** 14:49-15:11 The extracellular microenvironment modulates biological activity of diffusible growth factors during early mouse embryogenesis
マウス初期胚発生過程において細胞外の微小環境が、拡散性成長因子のシグナル活性を制御している
○Isao Matsuo¹, Ryuji Hiramatsu², Chiharu Kimura-Yoshida¹ (Osaka Medical Center and Research Institute for Maternal and Child Health¹, Dept. Safty Res. Blood and Biol. Products, NIID²)
- S07-05** 15:11-15:33 Regulation of morphogen diffusion affects spontaneous pattern formation in development
モルフォゲンの拡散調節と発生における自発的パターン形成
○Takashi Miura (Dept. of Anat. & Cell Biol., Kyushu Univ. Grad. Sch. of Med.)
- S07-06** 15:33-15:55 Visualization of Wnt proteins reveals their local accumulation in developing tissues
Wntタンパク質の可視化により明らかになった発生組織における局所的集積
Yusuke Mii^{1,2,3}, Kei Nakayama^{1,2,3}, Takuma Shinozuka^{1,2,3}, ○Shinji Takada^{1,2,3} (OIIB, NINS¹,

NIBB², SOKENDAI³)

15:55-16:00 Conclusion

Symposium 8: A Contact Point Between Pluripotency and Germness

May 30 (Fri) 13:30-16:00 Room B
Organizers: Satoru Kobayashi (NIBB)
Yasuhisa Matsui (Tohoku Univ.)

Germline is the specialized cell lineage that produces gametes to transmit genetic materials from one generation to the next in sexual reproduction. In certain animals, such as *Drosophila*, the germline is specified by maternal factors stored in the specialized ooplasm, or germ plasm, while in other groups, including hydra, sea urchin, planaria and mouse, the germline is segregated from pluripotent (multipotent) cells by zygotic mechanism. Some germline genes, *vasa* and *nanos*, have been reported to be expressed in the pluripotent cells, as well as in germline, suggesting that these two cell types share a common characteristic. This symposium focuses on a connection between pluripotency and germness in various animals with different mode of germline segregation.

- S08-01** 13:30-13:45 Germline formation by maternal factors in *Drosophila* embryos
ショウジョウバエ胚における母性因子による生殖系列の形成
○Satoru Kobayashi (NIBB)
- S08-02** 13:45-14:00 Germline formation from multipotent stem cells in *Hydra*.
ヒドラにおける多能性幹細胞からの生殖幹細胞の再生
○Chiemi Nishimiya-Fujisawa¹, Satoru Kobayashi¹ (NIBB¹, NIBB²)
- S08-03** 14:00-14:30 A broad utilization of germ line molecules in multipotent cells of the sea urchin
○Mamiko Yajima, Gary Wessel (MCB Department, Brown Univ.)
- S08-04** 14:30-15:00 Germ cell development and regeneration in planarians: implications for understanding parasitic flatworms
Bo Wang, Jim Collins, ○Phillip Newmark (Howard Hughes Medical Institute Department of Cell and Developmental Biology University of Illinois at Urbana-Champaign)
- S08-05** 15:00-15:20 In vitro germline formation from pluripotent cells in mice
マウス生殖細胞系列の体外培養系での再構築
○Katsuhiko Hayashi^{1,2,3}, Mitinori Saitou^{1,4,5,6} (Kyoto Univ.¹, PRESTO, JST², Kyushu Univ.³, ERATO, JST⁴, CiRA, Kyoto Univ.⁵, iCeMS, Kyoto Univ.⁶)
- S08-06** 15:20-16:00 Epigenetic barrier between pluripotency and germness in mice
多能性と生殖細胞性を隔てるエピゲノム障壁
○Yasuhisa Matsui, Ikuma Maeda (IDAC, Tohoku Univ.)

Symposium 9: Making Conceptual Breakthroughs in Regenerative Biology and Medicine

May 30 (Fri) 13:30-16:00 Room C

Organizers: Yoshihiko Umesono (Univ. of Hyogo)

Akira Sato (Okayama Univ.)

Regeneration is one of the most intriguing phenomena in postembryonic development, made possible by extraordinary plasticity of cells in response to wounding in a context-dependent manner. “How do planarians regenerate their missing head and tail by activating pluripotent stem cells?” “How do axolotls regenerate their missing limbs and spinal cord?” “Why can newborn mice regenerate their damaged heart, but mice in adulthood cannot?” Unveiling the molecular logics behind these questions will contribute to developing better treatments for damaged tissues and organs, with the assistance of regenerative engineering.

- S09-01** 13:30-14:00 Why does regenerative ability vary among animal species? - a case study in planarians -
プラナリア種間における頭部再生能の違いに関する解析
○Yoshihiko Umesono (Univ. of Hyogo)
- S09-02** 14:00-14:30 Deconstructing the complexity of spinal cord regeneration
○Akira Tazaki (CRTD, TU Dresden)
- S09-03** 14:30-15:00 Transformation from skin wound healing to limb formation by defined factors in urodele amphibians
有尾両生類において皮膚損傷反応を四肢形成（再生）反応に転換させることができる「再生薬」の同定
Aki Makanae, Kazumasa Mitogawa, ○Akira Satoh (Research Core for Interdisciplinary Sciences (RCIS))
- S09-04** 15:00-15:30 Partial reprogramming for heart cell survival
部分的な若返りによる心臓細胞の生存機構
○Jun.K Takeuchi^{1,2,3} (IMCB, the University of Tokyo¹, Dept. of Bio. Sci., Grad. Sch. of Sci., U of Tokyo², JST PRESTO³)
- S09-05** 15:30-16:00 MEMS and microfluidic technologies for reconstructing tissue
MEMS とマイクロ流体技術による組織構築
○Hiroaki Onoe (IIS, The Univ. of Tokyo)

Workshops

Workshop 1: New Genome Technologies in Developmental Biology

May 28 (Wed) 16:00 ~ 19:00 Room A

Chairpersons: Atsuo Kawahara (Yamanashi Univ., RIKEN QBiC)

Takashi Yamamoto (Hiroshima Univ.)

The development of genome editing technologies (TALEN and CRISPR/Cas) and the discovery of a new transposon, *Albatross*, has enabled us to manipulate a targeted genome modification in various model organisms. In this workshop, we will introduce new genome technologies and their applications in developmental biology.

- WS1-01** 16:00-16:25 CRISPR/Cas9-mediated genome modifications in zebrafish
ゼブラフィッシュにおける CRISPR/Cas9 によるゲノム編集
○Atsuo Kawahara^{1,2}, Satoshi Ota^{1,2}, Yu Hisano² (Yamanashi Univ.¹, RIKEN QBiC²)
- WS1-02** 16:25-16:40 O-Fucosyltransferase activity of Pofut1 is necessary to regulate correct Notch1 subcellular localization during somitogenesis
Pofut1 糖鎖修飾活性は体節形成時の Notch1 細胞内局在制御に必須である
○Rieko Ajima¹, Yoshiaki Okamura^{1,2}, Yumiko Saga¹ (NIG¹, KDRI²)
- WS1-03** 16:40-16:55 Targeted gene disruptions in the cricket, *Gryllus bimaculatus*, using CRISPR/Cas9 system
CRISPR/Cas9 システムを用いたコオロギにおける標的遺伝子破壊
○Takahito Watanabe¹, Yuji Matsuka², Taro Mito³, Sumihare Noji^{1,3} (CCAIC, Univ. of Tokushima¹, Dept. of Bio. Sci. and Tech., Fact. of Eng., Univ. of Tokushima², Dept. of Life Syst., Inst. of Tech. and Sci., Univ. of Tokushima³)
- WS1-04** 16:55-17:15 Gene discovery by forward genetics in mammalian system
哺乳動物における順遺伝学による遺伝子解析
○Junji Takeda (Grad. Sch. Med, Osaka Univ.)
- WS1-05** 17:15-17:30 The largest DNA transposon, *Albatross* -its evolution and application
最大の DNA トランスポゾン *Albatross* - その進化と応用
○Yusuke Inoue¹, Takumi Aikawa¹, Mariko Kondo², Shinichi Morishita³, Kiyoshi Naruse⁴, Atsuko Shimada¹, Akihiko Koga⁵, Hiroyuki Takeda¹ (Univ. of Tokyo, Grad. Sch. of Sci.¹, Univ. of Tokyo, MMBS², Univ. of Tokyo, Dept. of Comp. Biol³, NIBB, Lab. of Biores.⁴, Kyoto Univ., Primate Res. Inst.⁵)
- WS1-06** 17:30-17:45 Evolutionary origin of the turtle shell: insights from a comparative transcriptomics analysis
○Juan Pascual-Anaya, Shigeru Kuratani (RIKEN CDB)
- WS1-07** 17:45-18:00 SraTailor: GUI software for visualizing high-throughput sequence read archives
既報の NGS 生データを簡単に可視化するソフトウェア
○Shinya Oki¹, Kazumitsu Maehara², Yasuyuki Ohkawa², Chikara Meno¹ (Department of developmental Biology, Graduate School of Medical Sciences, Kyushu University¹, Department of Epigenetics, Graduate School of Medical Sciences, Kyushu University²)
- WS1-08** 18:00-18:20 Knockout of genes in the chordate *Ciona intestinalis*
カタユウレイボヤにおける遺伝子ノックアウト
Nicholas Treen¹, Haruka Sasaki¹, Keita Yoshida¹, Akiko Hozumi¹, Tetsushi Sakuma²,

Takashi Yamamoto², [○]Yasunori Sasakura¹ (Shimoda Marine Res. Center, Univ. Tsukuba¹, Dept. Math and Life Sci. Grad. Sch. Sci. Hiroshima Univ.²)

- WS1-09** 18:20-18:40 TALEN-mediated genome editing is very useful in Iberian ribbed newts (*Pleurodeles waltl*), an experimental model animal for regeneration
TALEN を介したゲノム編集は、イモリ再生研究の強力なツールとなる
[○]Toshinori Hayashi¹, Kousuke Sakamoto¹, Tetsushi Sakuma², Ayumi Myouga¹, Naoki Yokotani¹, Takeshi Inoue³, Eri Kawaguchi³, Kiyokazu Agata³, Takashi Yamamoto², Takashi Takeuchi¹ (School of Life Science, Tottori Univ.¹, Graduate School of Science, Hiroshima Univ.², Graduate School of Science, Kyoto Univ.³)
- WS1-10** 18:40-19:00 Targeted genome editing using Platinum TALENs
Platinum TALEN を用いた標的遺伝子の編集
[○]Takashi Yamamoto, Kenichi Suzuki, Tetsushi Sakuma (Dept. of Math. and Sci., Hiroshima Univ.)

Workshop 2: Frontiers in Developmental Biology by Unique Approaches

May 29 (Thu) 16:00 ~ 19:00 Room A

Chairpersons: Takayuki Suzuki (Nagoya Univ.)

Tatsuya Takemoto (Univ. of Tokushima)

Recent progresses in technologies such as imaging, big data analysis and genome editing innovate in developmental biology. This workshop introduces researchers that could find a new understanding during embryogenesis using a new approach. They will describe the details that how they think and establish original experimental approaches to promote their science. We propose that speakers and audience equally discuss the new principle of developmental biology actively in the workshop.

- WS2-01** 16:00-16:18 Specification of the hindlimb position and its diversity in tetrapods
四肢動物における後肢の位置の多様性とその決定機構
[○]Takayuki Suzuki¹, Yoshiyuki Matsubara¹, Ayumi Hattori², Yusuke Watanabe², Atsushi Sakai³, Guojun Sheng⁴, Toshihiko Ogura², Atsushi Kuroiwa¹ (Div. of Biol. Sci., Nagoya Univ.¹, IDAC, Tohoku University², Snake Inst.³, RIKEN, CDB⁴)
- WS2-02** 16:18-16:36 Visualization of ATP levels in vivo
生体内の ATP 量と変動の可視化
[○]Masamichi Yamamoto (ASRLD Unit, Gunma Univ.)
- WS2-03** 16:36-16:54 Epigenetic regulation of mouse sex determination by histone demethylation
ヒストンの脱メチル化によるマウスのエピジェネティックな性決定機構
[○]Makoto Tachibana (IER, Tokushima Univ.)
- WS2-04** 16:54-17:12 Transcription factors interfering with dedifferentiation induce cell type-specific transcriptional profiles
初期化を阻害する転写因子が分化を促進する
[○]Shinji Masui (CiRA, Kyoto Univ.)
- WS2-05** 17:12-17:30 Pioneer transcription factor FoxA maintains exposed nucleosomal structure at tissue-specific enhancers
パイオニア転写因子 FoxA による組織特異的エンハンサーのクロマチン構造の制御
[○]Makiko Iwafuchi-Doi¹, Greg Donahue¹, Jason Watts¹, Shaun Mahony³, Franklin Pugh³, Dolim Lee², Klaus Kaestner², Kenneth Zaret¹ (CDB, UPenn¹, IDOM, UPenn², Penn State

Univ.³)

- WS2-06** 17:30-17:48 Molecular regulation of the basement membrane integrity during chicken gastrulation
ニワトリ原腸陥入において基底膜制御に関わる分子メカニズム
○Yukiko Nakaya¹, Erike W. Sukowati¹, Guojun Sheng¹ (CDB, RIKEN¹, CDB, RIKEN²)
- WS2-07** 17:48-18:06 Towards the understanding of horn development in the Japanese rhinoceros beetle
カブトムシの角形成メカニズムの解明をめざして
○Teruyuki Niimi (Grad. Sch. of Bioagr. Sci., Nagoya Univ.)
- WS2-08** 18:06-18:24 A novel defined factor directly specifies cardiac lineages from pluripotent stem cells and promotes heart regeneration
新規心臓転写因子による直接心臓運命決定と心臓再生
○Yuika Morita^{1,2}, Yuko Tsukahara¹, Ryuichi Nishinakamura³, Kazuko Koshiba-Takeuchi¹, Jun K. Takeuchi^{1,2,4} (Cardiovas. Reg. IMCB, the Univ. of Tokyo¹, Graduate School of Sciences, the Univ. of Tokyo², CARD, Kumamoto Univ³, JST PRESTO⁴)
- WS2-09** 18:24-18:42 Mechanics of epithelial invagination: morphogenetic forces and stabilization of tissue architecture in *Drosophila* tracheal placode.
ショウジョウバエ気管原基陥入機構：形態形成運動を引き起こす力と組織形態の安定化
○Takefumi Kondo, Shigeo Hayashi (RIKEN CDB)
- WS2-10** 18:42-19:00 Anisotropic stress orients remodelling of mammalian limb bud ectoderm
異方性応力が肢芽上皮のリモデリングの方向性を決定づける
○Hirotao Tao¹, Kimberly Lau¹, Haijiao Liu², Jun Wen², Kendra Sturgeon¹, Natalie Sorfa-zlian¹, Michael Wong³, Savo Ladic^{1,4}, Danyi Li^{1,4}, Steven Deimling¹, Ian Scott^{1,4}, Brian Ciruna^{1,4}, R. Henkelman³, Trevor Williams⁵, Anna-Katerina Hadjantonakis⁶, Rodrigo Fernandez-Gonzalez⁷, Yu Sun², Sevan Hopyan^{1,4,8} (Program in Developmental and Stem Cell Biology, The Hospital for Sick Children¹, Department of Mechanical and Industrial Engineering, University of Toronto², Mouse Imaging Centre, The Hospital for Sick Children, Toronto Centre for Phenogenomics, Department of Biomedical Physics, University of Toronto³, Department of Molecular Genetics, University of Toronto⁴, Program in Molecular Biology, School of Medicine, University of Colorado⁵, Developmental Biology Program, Sloan-Kettering Institute⁶, Institute of Biomaterials and Biomedical Engineering, University of Toronto⁷, Division of Orthopaedic Surgery, The Hospital for Sick Children and University of Toronto⁸)

Oral Presentations (in English)

OP01: Neural Development and Behavior / Technology, Theoretical Approach, Systems Biology

May 27 (Tue) 16:30 ~ 19:30 Room A

Chairpersons: Tatsumi Hirata (NIG)

Koichi Kawakami (NIG)

- OP01-01** 16:30-16:45 NOVEL ROLE OF FGF SIGNALING IN EYE DEVELOPMENT
マウス眼の発生における FGF シグナリングの新たな機能
Takaya Abe¹, Deepa Murali², Yui Yamashita¹, [○]Yasuhide Furuta¹ (RIKEN CDB¹, UT MDACC²)
- OP01-02** 16:45-17:00 Conditional knock-out of mouse Shh and Ptch1 genes during cortical neurogenesis at late gestation
マウス胎生後期終脳皮質形成期における Shh と Ptch1 の遺伝子破壊
[○]Jun Motoyama (Brain, Doshisha Univ.)
- OP01-03** 17:00-17:15 Schwann cell precursor-like cells are a novel neuronal origin of the enteric nervous system
腸神経系を形成する新たな細胞ソースの同定
[○]Toshihiro Uesaka, Hideki Enomoto (NDR/Kobe Univ.)
- OP01-04** 17:15-17:30 A dual role for Isl1 in promoting striatonigral and repressing striatopallidal genetic programs to specify striatonigral cell identity
[○]Kuan-Ming Lu¹, Sylvia Evans², Shinji Hirano³, Fu-Chin Liu¹ (INS, NYMU¹, SSP, UCSD², DNA, KMS³)
- OP01-05** 17:30-17:45 Neural activity regulates restoration of the brain function during head regeneration in planarian
外部刺激による神経活動がプラナリアの脳再生過程において脳機能の回復を制御する
[○]Takeshi Inoue¹, Tomomi Takano², Yoshihiko Umesono¹, Kiyokazu Agata¹ (Dep. of Biophys, Grad. Sch. of Sci., Kyoto Univ.¹, CDB, RIKEN²)
- OP01-06** 17:45-18:00 Microtubule associated protein tau (Mapt) affects development and plasticity of dendrites.
[○]Torsten Bullmann¹, Corina Barbu², Max Holzer², Thomas Arendt² (QBiC, RIKEN¹, PFI, Leipzig Univ.²)
- OP01-07** 18:00-18:15 Directional control of the escape locomotion in zebrafish
ゼブラフィッシュ逃避行動におけるロコモーションの方向制御
[○]Kazuhide Asakawa^{1,2}, Gembu Abe¹, Koichi Kawakami^{1,2} (NIG¹, SOKENDAI²)
- OP01-08** 18:15-18:30 Regulation of proneural wave progression by EGF and Notch signalings
EGF と Notch による「分化の波」の制御機構
[○]Makoto Sato¹, Takashi Miura², Masaharu Nagayama³ (Kanazawa Univ¹, Kyushu University², Hokkaido University³)
- OP01-09** 18:30-18:45 Determining sensitivity of chemical reaction systems: a function-free approach
化学反応ネットワークの攪乱応答を関数非依存に決定する
[○]Atsushi Mochizuki¹, Bernold Fiedler² (Theor Biol Lab, RIKEN¹, Inst. Math, Free Univ Berlin²)

- OP01-10** 18:45-19:00 A Quantitative Approach to Spatial Temporal Dynamics in Developmental Biology
 ◯Kenneth Ho¹, Yukato Tohsato¹, Koji Kyoda¹, Shuichi Onami^{1,2} (Lab. Dev. Dyn., RIKEN QBiC¹, NBDC, JST²)
- OP01-11** 19:00-19:15 Blue light-mediated manipulation of transcription factor activity in zebrafish embryos
 光の ON/OFF で多細胞生物の遺伝子発現を時空間的に制御する新技術“PICCORO”
 Shinji Masuda^{2,3}, Yuki Nakatani¹, Shukun Ren², ◯Mikiko Tanaka¹ (Grad. Sch. of Biosci. & Biotechnol., Tokyo Inst. of Technol.¹, CBRI, Tokyo Inst. of Technol.², Earth-Life Sci. Inst., Tokyo Inst. of Technol.³)

OP02: Stem Cells and Regeneration

May 27 (Tue) 16:30 ~ 19:30 Room B

Chairpersons: Kunimasa Ohta (Kumamoto Univ.)

Yoshihiko Umesono (Univ. of Hyogo)

- OP02-01** 16:30-16:45 Redefining the in vivo Origin of Nephron Progenitors Enables Generation of Three-dimensional Kidney Structures from Pluripotent Stem Cells in vitro
 腎臓初期発生の新規モデルと多能性幹細胞からの三次元腎臓組織の構築
 ◯Atsuhiko Taguchi, Ryuichi Nishinakamura (IMEG)
- OP02-02** 16:45-17:00 Tooth regeneration with the cooperative action of osteoclasts and osteoblasts
 破骨細胞と骨芽細胞の協調した働きによる歯再生
 ◯Akiko Mantoku, Masahiro Chatani, Keiji Inohaya, Akira Kudo (Tokyo Institute of Technology)
- OP02-03** 17:00-17:15 Analysis of the reintegration of the regenerated and remaining tissues during limb joint regeneration in newts and frogs
 イモリとカエルの四肢関節再生過程で再生部と残存部が調和する仕組みの研究
 ◯Rio Tsutsumi, Takeshi Inoue, Kiyokazu Agata (Dept. of Biophys., Grad. Sch. of Sci, Kyoto Univ.)
- OP02-04** 17:15-17:30 Laminins function as an ECM niche for trophoblast stem cells
 ラミニンは栄養膜幹細胞の ECM ニッチである
 ◯Daiji Kiyozumi¹, Itsuko Nakano¹, Yuya Sato¹, Chisei Shimono¹, Yukimasa Taniguchi¹, Ryoko Sato-Nishiuchi¹, Akio Ozawa¹, Satoshi Tanaka², Kiyotoshi Sekiguchi¹ (IPR, Osaka Univ.¹, Univ. of Tokyo²)
- OP02-05** 17:30-17:45 Tsukushi maintains the growth and undifferentiated properties of brain neuronal stem/progenitor cells as niche molecule
 Tsukushi は脳神経幹細胞の増殖と未分化状態をニッチ分子として制御する
 Ayako Ito, Yohei Shinmyo, Naofumi Ito, Rie Kawano, Athary Felemban, Hideaki Tanaka, ◯Kunimasa Ohta (Dept. of Dev. Neurobiol., Kumamoto Univ. Grad. Sch. of Life Scis.)
- OP02-06** 17:45-18:00 Molecular mechanisms of tissue regeneration from adult pluripotent stem cells in planarians

プラナリアにおける全能性幹細胞からの組織再生の分子機構

○Norito Shibata¹, Nobuyoshi Kumagai¹, Tetsutaro Hayashi², Kiyokazu Agata¹ (Dept. of Biophys, Kyoto Univ.¹, Bioinformatics Research Unit, ACCC, RIKEN²)

- OP02-07** 18:00-18:15 Molecular analysis of *grimp*, a gene involved in early regeneration of *Enchytraeus japonensis* (Enchytraeidae, Oligochaeta)
ヤマトヒメミズ再生初期に重要な役割を持つ遺伝子 *grimp* の分子解析
○Chikako Yoshida-Noro^{1,2}, Asuka Toshima¹, Ayako Nakayama¹, Yoshikazu Mikami³, Shin Tochinnai⁴ (Dep. Appl. Mol. Chem., Nihon Univ.¹, Div. Cell Regen. Transpl., Nihon Univ. Sch. Med.², Depart. Pathol. Nihon Univ, Sch. Dent.³, Fac. Sci. Hokkaido Univ.⁴)
- OP02-08** 18:15-18:30 *WOX13*-like genes are required for reprogramming of leaf and protoplast cells into stem cells in the moss *Physcomitrella patens*
ヒメツリガネゴケ *WOX13L* 遺伝子は葉分化細胞から幹細胞へのリプログラミングに必須である
○Keiko Sakakibara^{1,2,3,4}, Pascal Reisewitz^{5,6}, Tsuyoshi Aoyama^{1,7}, Thomas Friedrich⁵, Sayuri Ando^{1,2}, Yoshikatsu Sato^{1,2}, Yosuke Tamada^{1,7}, Tomoaki Nishiyama^{2,8}, Yuji Hiwatashi^{1,7}, Tetsuya Kurata^{1,2}, Masaki Ishikawa^{1,2,7}, Hironori Deguchi⁴, Stefan Rensing⁹, Wolfgang Werr⁶, Takashi Murata^{1,7}, Mitsuyasu Hasebe^{1,2,7}, Thomas Laux⁵ (Science, Tokyo Univ.¹, NIBB², Hasebe ERATO project³, Hiroshima Univ.⁴, Freiburg University⁵, Universität Köln⁶, Graduate University for Advanced Studies⁷, Kanazawa University⁸, University of Marburg⁹)
- OP02-09** 18:30-18:45 Identification of a potential progenitor cell population with clonal proliferation activity in the biliary system in regenerating mouse liver
マウス肝臓の再生過程における胆管系前駆細胞の性状解析
○Kenji Kamimoto^{1,2}, Kota Kaneko^{1,2}, Tohru Itoh^{1,2}, Atsushi Miyajima^{1,2} (IMCB, The University of Tokyo¹, Department of Biophysics and Biochemistry, Graduate School of Science, the University of Tokyo²)
- OP02-10** 18:45-19:00 *Sox5* controls a fate choice during pigment cell development in medaka
Sox5 はメダカ色素細胞発生において細胞運命の決定を制御している
○Yusuke Nagao¹, Tomoko Adachi^{2,3}, Atsushi Shimizu⁴, Ryoko Seki², Chikako Inoue², Yasuhiro Kamei⁵, Ikuyo Hara⁵, Tetsuaki Kimura⁵, Yoshihito Taniguchi⁶, Kiyoshi Naruse⁵, Robert Kelsh³, Yuko Wakamatsu², Masahiko Hibi², Hisashi Hashimoto² (Grad. Sch. Sci., Nagoya Univ.¹, Biosci. Biotech. Ctr., Nagoya Univ.², Dept. of Biol. Biochem., Univ. of Bath³, Iwate Tohoku Medical Megabank Organization, Iwate Med. Univ.⁴, NIBB⁵, Sch. of Med., Keio Univ.⁶)
- OP02-11** 19:00-19:15 A trophic factor derived from the myeloid cells supports the survival and proliferation of blastema during tissue regeneration in zebrafish
ゼブラフィッシュの組織再生において、ミエロイド系細胞由来の栄養因子が再生芽の増殖と生存を支持する
○Tomoya Hasegawa, Teruhiro Nakajima, Takashi Ishida, Akira Kudo, Atsushi Kawakami (Tokyo tech)
- OP02-12** 19:15-19:30 Two distinct roles of a planarian *yorkie*-related gene during regeneration and homeostasis
○Byulnim Hwang¹, Kiyokazu Agata¹, Yoshihiko Umesono² (Kyoto Univ.¹, Department of Life systems, Institute of Technology and Science, University of Tokushima²)

OP03: Signaling in Development

May 27 (Tue) 16:30 ~ 19:30 Room C
Chairpersons: Tohru Ishitani (Kyushu Univ.)
Tomoko Yamakawa (Osaka Univ.)

- OP03-01** 16:30-16:45 Identification of genetic modifiers that interact with *pecanex*, encoding a component of Notch signaling in *Drosophila*
Notch シグナル伝達系構成因子、Pecanex と遺伝的に相互作用する調節遺伝子の網羅的探索
○Tomoko Yamakawa, Yu Atsumi, Shiori Kubo, Kenji Matsuno (Dept. of Biol. Sci., Grad. school of Sci., Osaka Univ.)
- OP03-02** 16:45-17:00 Functional analysis of lipid metabolism genes affecting developmental signaling pathways
シグナル伝達系における脂質代謝酵素の機能解析
○Takeshi Sasamura¹, Kenji Matsuno¹, Mark Fortini² (Dept. Biol. Sci., Grad. Sch. Sci., Osaka Univ.¹, Dept. Biochem, Thomas Jefferson Univ.²)
- OP03-03** 17:00-17:15 Hipk2 and PP1c-mediated dephosphorylation of Dishevelled sustains Wnt signal transduction
Hipk2 と PP1c による Dishevelled タンパク質の脱リン酸化は Wnt シグナルの伝達を支える
Nobuyuki Shimizu¹, Shizuka Ishitani¹, Atsushi Sato², Hiroshi Shibuya², ○Tohru Ishitani¹ (Div. of Cell Reg. Sys., Med. Ins. of Bioreg., Kyushu Univ.¹, ep. of Mol. Cell. Biol., Med. Res. Inst., Tokyo Med. and Dent. Univ.²)
- OP03-04** 17:15-17:30 Gli3 repressor is required to mediate the timing of mammalian cochlear hair cell differentiation
○Boshi Wang¹, Elaine Y.M. Wong¹, Hong Huan Hor¹, Chi Chung Hui², Mai Har Sham¹ (Department of Biochemistry, Li Ka Shing Faculty of Medicine, The University of Hong Kong, Pokfulam, Hong Kong¹, Program in Developmental and Stem Cell Biology, The Hospital for Sick Children, Toronto, Canada²)
- OP03-05** 17:30-17:45 Kinocilia-specific Transport during Inner Ear Hair Cell Development
内耳有毛細胞のキノシリア形成における FGF シグナルの役割
○Akira Honda, Tomoko Kita, Kazuyo Misaki, Reiko Nakagawa, Shigenobu Yonemura, Raj Ladher (RIKEN-CDB)
- OP03-06** 17:45-18:00 Regulatory mechanisms of the nutrient-dependent expression of a *Drosophila* insulin-like peptide
ショウジョウバエインスリン様ペプチドの栄養依存的発現制御機構
○Naoki Okamoto, Takashi Nishimura (RIKEN, CDB)
- OP03-07** 18:00-18:15 A genetic screen identifies modifiers of human APP in *Drosophila*
○Pu Ren, Lei Xue (SLST, Tongji Univ)
- OP03-08** 18:15-18:30 The canonical Wnt/Wingless signaling mediates JNK induced cell death in *Drosophila*
○Shiping Zhang, Xiaowei Guo, Lei Xue (SLST, Tongji Univ.)
- OP03-09** 18:30-18:45 The IRAK Homolog Pelle negatively regulates JNK-dependent cell death in *Drosophila*
○Chenxi Wu, Lei Xue (SLST, Tongji Univ)

- OP03-10** 18:45-19:00 Oncoprotein Myc suppressed JNK-mediated cell migration in *Drosophila*
 ◦Xianjue Ma, Jiahong Huang, Yujun Chen, Lei Xue (SLST, Tongji Univ.)
- OP03-11** 19:00-19:15 Src42A Modulates Tumor Invasion and Cell Death via Ben/dUev1a-JNK Signaling in *Drosophila*
 ◦Yingyao Shao, Xianjue Ma, Hongyu Zheng (Shanghai Key Laboratory of Signaling and Disease Research, Tongji Univ.)

OP04: Early Embryogenesis / Evolution and Development

May 28 (Wed) 16:00 ~ 19:00 Room B
 Chairpersons: Hiroki Kuroda (Keio Univ.)
 Hiroshi Wada (Tsukuba Univ.)

- OP04-01** 16:00-16:15 Mechanism that determines the mesoderm region through nuclear migration in the ascidian embryo.
 ◦Naohito Takatori, Hidetoshi Saiga (Tokyo Met. Univ.)
- OP04-02** 16:15-16:30 Analysis of the transcription regulatory mechanism of *Otx* gene in the cells to form the neural tube in two ascidian species, *Halocynthia roretzi* and *Ciona intestinalis*
 ホヤの神経管の発生における *Otx* 遺伝子の転写制御機構の比較解析
 ◦Kouhei Oonuma, Naohito Takatori, Hidetoshi Saiga (Dept. Biol. Sci., Tokyo Metropol. Univ.)
- OP04-03** 16:30-16:45 Origin of the asymmetry in mouse embryo.
 マウス胚における非対称性の起源
 ◦Katsuyoshi Takaoka (Osaka University FBS)
- OP04-04** 16:45-17:00 Mechanism of microtubule-dependent dorsal determination in zebrafish
 ゼブラフィッシュにおける微小管依存性背側決定機構
 ◦Hiromu Hino¹, Masahiko Hibi^{1,2}, Takashi Shimizu^{1,2}, Ryoko Seki², Francisco Pelegri³
 (Grad. Sch. Sci., Nagoya Univ.¹, BBC, Nagoya Univ.², Lab. Genetics, UWM³)
- OP04-05** 17:00-17:15 NFκB regulates dorsoventral patterning in zebrafish embryos.
 NFκB はゼブラフィッシュ初期胚において背腹軸形成を制御する
 ◦Satoshi Anai, Satoshi Ota, Tohru Ishitani (Cell. Reg. Sys., MIB, Kyushu Univ.)
- OP04-06** 17:15-17:30 A novel role for Sonic Hedgehog signalling in the morphogenesis of Zebrafish spinal cord
 ◦Irene Gutiérrez-Vallejo, Elisa Martí (Instituto de Biología Molecular de Barcelona, CSIC, Parc Científic de Barcelona)
- OP04-07** 17:30-17:45 The role of Tbx6 in the derivation of mesodermal tissue from the axial stem cells
 体軸幹細胞から中胚葉細胞産出における Tbx6/Tbx6L の役割
 ◦Tatsuya Takemoto¹, Hisato Kondoh² (Fujii Memorial Inst. of Med. Sci., The Univ. of Tokushima¹, FBS, Osaka Univ.²)
- OP04-08** 17:45-18:00 Evolution of early development of lophotrochozoa: insight from lophotrochozoa specific homeobox genes.
 冠輪動物特有の新規ホメオボックス遺伝子群から探る初期発生の進化
 ◦Yoshiaki Morino, Naoki Hashimoto, Hiroshi Wada (Univ. of Tsukuba)

- OP04-09** 18:00-18:15 Functional analysis of the T-box transcription factor Brachyury in coral gastrula embryos
サンゴ原腸胚における T-box 転写因子 Brachyury の機能解析
○Yuuri Yasuoka, Ryo Koyanagi, Chuya Shinzato, Nori Satoh (OIST)
- OP04-10** 18:15-18:30 Developmental roles and evolution of the bicistronic microRNA precursor, miR-1/miR-133, expressed specifically in muscle tissues
筋肉特異的 microRNA 前駆体 miR-1/miR-133 の機能と進化
○Rie Kusakabe, Saori Tani, Kunio Inoue (Dept. Biol., Grad. Sch. Sci., Kobe Univ.)
- OP04-11** 18:30-18:45 Quantitative characterization of three distinct modes of stripe formation in a dynamic continuous epithelium of the spider embryo
クモ胚のダイナミックな上皮に見られる 3 つの縞形成様式の定量的特徴付け
Natsuki Hemmmi^{1,2}, Yasuko Akiyama-Oda¹, ○Hiroki Oda^{1,2} (JT BRH¹, Osaka Univ.²)
- OP04-12** 18:45-19:00 Anterior-posterior patterning of pectoral fin development in cartilaginous fishes: Insight into the fin-to-limb evolution
軟骨魚類の胸鰭の発生における前後軸パターン形成から得る鰭から四肢への進化への洞察
○Koh Onimaru¹, Shigehiro Kuraku², Wataru Takagi³, Susumu Hyodo³, Mikiko Tanaka⁴ (CRG¹, RIKEN CDB², UTokyo³, Tokyo Tech⁴)
- OP04-13** 19:00-19:15 Independent origins of the tympanic membrane and middle ear in different amniote taxa
哺乳類と双弓類(爬虫類、鳥類)は、独立に鼓膜と中耳を獲得した
○Taro Kitazawa¹, Masaki Takechi^{2,3}, Tatsuya Hirasawa³, Nicolas Narboux-Nême⁴, Hideaki Kume¹, Kazuhiro Maeda⁵, Sachiko Miyagawa-Tomita⁵, Yukiko Kurihara¹, Giovanni Levi⁴, Shigeru Kuratani³, Hiroki Kurihara¹ (Dept. Physiol. Chem. & Metab., Grad. Sc. of Med., Univ. of Tokyo¹, Iwate Medical University², CDB³, Muséum National, d'Histoire Naturelle⁴, Tokyo Women's Medical University⁵)

OP05: Morphogenesis

May 28 (Wed) 16:00 ~ 19:00 Room C

Chairpersons: Yoshio Wakamatsu (Tohoku Univ.)

Makoto Suzuki (NIBB)

- OP05-01** 16:00-16:15 Development of the lateral line canal system through a bone remodeling process in zebrafish
ゼブラフィッシュの側線管は骨リモデリングにより形成される
○Hironori Wada¹, Koichi Kawakami^{1,2} (NIG¹, SOKENDAI²)
- OP05-02** 16:15-16:30 Collective cell movement promotes synchronization of the segmentation clock
細胞の集団的移動は体節時計の同期を促進する
○Koichiro Uriu (Theoretical Biology Laboratory, RIKEN)
- OP05-03** 16:30-16:45 Cux2 refines the position of limbs along the body axis
○Shogo Ueda¹, Yasuko Kanazawa¹, Natsuno Suda¹, Ryo Yamada¹, Hisanobu Shimamura¹, Masashige Bando², Ryuichiro Nakato², Katsuhiko Shirahige², Mikiko Tanaka¹ (Tokyo Tech.¹, Univ. of Tokyo²)
- OP05-04** 16:45-17:00 Local increases in mechanical tension shape compartment boundaries by biasing cell intercalations

細胞間結合にかかる張力が細胞介入にバイアスをかけることによってコンパートメント境界を形成する

○Daiki Umetsu^{1,2}, Benoit Aigouy^{3,4}, Maryam Aliee^{5,6}, Suzanne Eaton³, Frank Jülicher⁵, Christian Dahmann¹ (RIKEN CDB¹, TUD, Germany², MPI-CBG, Germany³, IBDM, France⁴, MPI-PKS, Germany⁵, Université de Lyon, France⁶)

- OP05-05** 17:00-17:15 The molecular mechanisms of apical constriction during the invagination of the otic placode
○Xiao Rei Sai, Raj Ladher (RIKEN CDB)
- OP05-06** 17:15-17:30 Cellular machinery involved in heart elongation and looping.
○Hinako Kidokoro^{1,4}, Koji Tamura², Masataka Okabe³, Gary Schoenwolf¹, Yukio Saijoh¹ (Dept. of Neurobiology & Anatomy, University of Utah, SLC, UT, USA,¹, Dept. of Developmental Biology & Neurosciences, Tohoku University, Sendai, Japan², Dept. of Anatomy, The Jikei University School of Medicine, Tokyo, Japan³, Div. of Biological Science, Nagoya University, Nagoya, Japan⁴)
- OP05-07** 17:30-17:45 Wnt-dependent and –independent roles of Wnt signaling in the formation and migration of germline niche cells in *C. elegans*
線虫 *C. elegans* において生殖ニッチ細胞の形成と移動は Wnt 依存のおよび非依存的な Wnt シグナル経路によって制御されている。
○Shuhei So, Hitoshi Sawa (Multicell. Org. Lab., NIG)
- OP05-08** 17:45-18:00 Pattern Formation of Epithelial Tube by Mechanical Instability in Murine Epididymal Development
マウス精巣上体の発生過程における上皮管の座屈とパターン形成
○Tsuyoshi Hirashima (Lab of Growth Regulation, Kyoto Univ)
- OP05-09** 18:00-18:15 Origin of *Drosophila* trachea and endocrine organs from a segmentally repeated ectodermal precursor
○Carlos Sánchez-Higueras, Sol Sotillos, James Castelli-Gair Hombria (CABD)
- OP05-10** 18:15-18:30 Anaerobic glucose metabolism regulates neural tube formation
嫌氣的グルコース代謝による神経管形成制御
○Daisuke Sakai, Jun Motoyama (Doshisha University)
- OP05-11** 18:30-18:45 Male-specific ECM regulation underlying looping morphogenesis of *Drosophila*
ショウジョウバエ生殖器の回転形成に関与するオス特異的な ECM 制御
○Emi Maekawa¹, Aimi Tsukioka¹, Ayako Isomura¹, Kazuyo Misaki², Shigenobu Yonemura², Erina Kuranaga¹ (Laboratory for Histogenetic Dynamics, RIKEN CDB¹, Electron Microscope Laboratory, RIKEN CDB²)
- OP05-11** 17:00-17:15 Male-specific ECM regulation underlying looping morphogenesis of *Drosophila*
ショウジョウバエ生殖器の回転形成に関与するオス特異的な ECM 制御
○Emi Maekawa (Laboratory for Histogenetic Dynamics, RIKEN CDB)
- OP05-12** 18:45-19:00 Periodic contraction of actomyosin network contributes to convergence movements in zebrafish neurulation
周期的なアクトミオシンの収縮はゼブラフィッシュの神経管形成における収斂運動に寄与する

○Makoto Suzuki, Naoto Ueno (NIBB)

- OP05-13** 19:00-19:15 What principal direct the building-up of the spiculous skeleton of sponges?
カイメンの骨片骨格を組み上げるための基本原理とは何か?
○Noriko Funayama, Kotoe Kawai, Kiyokazu Agata (Dept. of Biophysics, Graduate School of Science, Kyoto Univ.)

OP06: Gene Expression and Epigenetics / Reproduction and Gametogenesis

May 29 (Thu) 16:00 ~ 19:00 Room B

Chairpersons: Makoto Kobayashi (Tsukuba Univ.)

Akira Nakamura (Kumamoto Univ.)

- OP06-01** 16:00-16:15 Genetic analysis of zebrafish time-keeping mechanisms by TALEN and CRISPR/Cas9
○Han Wang (Soochow University)
- OP06-02** 16:15-16:30 Enhancer sharing and promoter insulation from enhancer activities: spatial and temporal organization of gene regulation around the mouse *Shh* locus
Shh 遺伝子と周辺遺伝子間におけるエンハンサー活性の共有と遮蔽
○Takanori Amano, Tomoko Sagai, Toshihiko Shiroishi (NIG)
- OP06-03** 16:30-16:45 Polycomb mediates transcriptional activation of Meis2 through promoter-enhancer interaction
ポリコム因子群はプロモーター・エンハンサー間の相互作用を調節することで遺伝子発現活性化に寄与する
○Takashi Kondo¹, Kaori Kondo¹, Haruhiko Koseki² (KAST¹, RIKEN-IMS²)
- OP06-04** 16:45-17:00 MRG-1 acts as an epigenome interpreter of Lys36 methylation on histone H3 in *C. elegans* germline development
MRG-1 はヒストン H3K36 メチル化によるエピゲノム情報を読み取り *C.elegans* の生殖細胞形成に寄与する
○Teruaki Takasaki^{1,2}, Andreas Rechtsteiner², Thea Egelhofer², Jeremy Kreher², Erina Shigeyama¹, Hiroshi Sakamoto¹, Susan Strome² (Kobe University.¹, UC Santa Cruz²)
- OP06-05** 17:00-17:15 PRDM14 promotes active DNA demethylation through the TET-mediated base excision repair pathway in embryonic stem cells
PRDM14 による TET-塩基除去修復経路を介した能動的脱メチル化機構の解明
○Yoshiyuki Seki, Naoki Okashita (K.G. Univ.)
- OP06-06** 17:15-17:30 The Epigenetic Regulation in Mammalian Heart Regeneration
哺乳類心臓再生におけるエピジェネティック制御機構
○Ryo Nakamura^{1,2}, Kazuko Koshiba^{1,2}, Yuko Tsukahara², Tetsuo Sasano³, Yutaro Hori^{1,2}, Yuki Ando^{1,2}, Mizuyo Kojima², Tetsushi Furukawa³, Hesham Sadek⁴, Jun Takeuchi^{1,2,5} (Grad of Sci, Univ of Tokyo¹, IMCB, Univ of Tokyo², Medical Res. Inst., TMDU³, UT Southwestern⁴, JST PRESTO⁵)
- OP06-07** 17:30-17:45 Sall4 is essential for mouse primordial germ cell specification by suppressing the somatic cell program
Sall4 は、マウス生殖細胞形成において体細胞遺伝子の抑制に必須である。
○Satomi Tanaka¹, Yasuka Yamaguchi¹, Yasuhisa Matsui², Ryuichi Nishinakamura¹ (IMEG, Kumamoto Univ.¹, IDAC, Tohoku Univ.²)

- OP06-08** 17:45-18:00 Germ cell sexual differentiation requires Nanos2-mediated dosage control of *Dazl* in mice
 マウス始原生殖細胞の性分化における Nanos2 による *Dazl* の量的制御
 °Yuzuru Kato, Yumiko Saga (NIG)
- OP06-09** 18:00-18:15 *Smad2* and p38 signaling orchestrate the male fate decision of mouse PGC
 °Quan Wu, Yumiko Saga (NIG)
- OP06-10** 18:15-18:30 Peritubular cells expressing CXCL12/FGF5 sustain spermatogonial stem cells in mice
 CXCL12/FGF5 発現細胞は精子幹細胞を保持する
 °Yu Kitadate^{1,2}, Aumi Maruyama¹, Rie Ichikawa¹, Masatsugu Ema³, Fumihiro Sugiyama⁴, Satoru Takahashi⁵, Takashi Nagasawa⁶, Shosei Yoshida^{1,2} (NIBB¹, SOKENDAI², Research Center for Animal Life Science, Shiga University of Medical Sciences³, Laboratory Animal Resource Center, University of Tsukuba⁴, Department of Anatomy and Embryology, Institute of Basic Medical Sciences, Graduate School of Comprehensive Human Sciences, University of Tsukuba⁵, Department of Immunobiology and Hematology, Kyoto University⁶)
- OP06-11** 18:30-18:45 Mitotic regulation in *Drosophila* spermatogonia is mediated by Notch signaling and a nuclear receptor complex acting in somatic stromal cells
 ショウジョウバエ精原細胞の分裂は間質細胞における Notch シグナルと核内受容体複合体の働きにより介在されている
 Kohei Kawaguchi¹, Takehiro Kajihara¹, Mizuho Inai¹, Yasushi Hiromi², °Hiroyuki Kose¹ (International Christian University¹, National Institute of Genetics²)
- OP06-12** 18:45-19:00 Sperm-derived TRP-3 channel mediates the onset of the fertilization calcium wave in *C. elegans*
 精子由来 TRP-3 チャンネルは *C. elegans* において受精カルシウム波を開始させる。
 °Jun Takayama, Shuichi Onami (RIKEN QBiC)

OP07: Cell Biology / Organogenesis

May 29 (Thu) 16:00 ~ 19:00 Room C
 Chairpersons: Shizue Ohsawa (Kyoto Univ.)
 Mitsuru Morimoto (RIKEN CDB)

- OP07-01** 16:00-16:15 Cell chirality in animal morphogenesis
 細胞のキラリティによる動物の形態形成
 Ryo Hatori, Alice Tsuboi, Mai Adachi, Tomoki Ishibashi, °Kenji Matsuno (Dept. Biol. Sci., Osaka Univ.)
- OP07-02** 16:15-16:30 Integration of local and global IKK ϵ signaling regulates polarized cell elongation
 IKK ϵ による局所シグナル伝達は細胞伸長過程における細胞極性維持に必要である
 °Tetsuhisa Otani, Kenzi Oshima, Akiyo Kimpara, Michiko Takeda, Shigeo Hayashi (RIKEN CDB, Lab for Morphogenetic Signaling)
- OP07-03** 16:30-16:45 Dissecting the mechanism of cell competition that regulates epithelial homeostasis in *Drosophila*
 上皮の恒常性維持を司る細胞競合の遺伝学的解析
 °Shizue Ohsawa¹, Kei Kunimasa¹, Tatsushi Igaki^{1,2} (Lab. Genetics, Grad. Sch. Biostudies,

Kyoto Univ.¹, PRESTO, JST²)

- OP07-04** 16:45-17:00 Cell cycle exit in cardiomyocytes is initiated by p21Cip1 and p27Kip1, and maintained by two inhibitory systems
心筋細胞の細胞周期離脱は p21Cip1 と p27Kip1 によって開始され、その後 2 つの阻害機構により維持される
○Shoji Tane, Hitomi Okayama, Aiko Ikenishi, Yukio Satoh, Takashi Takeuchi (Dev. Bio-signal., Sch. Life Sci., Tottori Univ.)
- OP07-05** 17:00-17:15 An ON-OFF boundary of FGF/Erk signal activity marks the earliest future somite boundary in zebrafish
ゼブラフィッシュにおいて、FGF/ERK シグナルの活性境界は、最も早い予定分析境界を規定する
Ryutaro Akiyama^{1,2}, Dini Sari¹, Shoichiro Tsuge¹, Miwa Masuda^{1,3}, Yasumasa Bessho¹,
○Takaaki Matsui¹ (NAIST¹, Univ. Minnesota², RIKEN BSI³)
- OP07-06** 17:15-17:30 TALEN-mediated gene disruption reveals roles of Mesp transcriptional factors in the segmentation and differentiation of somites in zebrafish development.
ゼブラフィッシュ体節形成における mesp 遺伝子の機能解析
○Taijiro Yabe¹, Chimwar Wanglar¹, Takashi Yamamoto², Kazuyuki Hoshijima³, Shinji Takada¹ (NIBB¹, Hiroshima Univ.², The Univ. of Utah³)
- OP07-07** 17:30-17:45 E-cadherin-dependent cell adhesion regulates cell migration pattern in the zebrafish lens epithelium
ゼブラフィッシュ水晶体上皮細胞において E-カドヘリン依存的細胞接着が細胞の挙動を制御する
○Toshiaki Mochizuki, Yi-Jyun Luo, Shohei Suzuki, Ichiro Masai (OIST)
- OP07-08** 17:45-18:00 Functional analysis of the TGF- β pathway in hepatoblasts during mouse hepatic histogenesis
マウス肝組織形成時の肝芽細胞における TGF- β 経路の機能解析
○Yuji Yokouchi¹, Daiki Yoshii², Hiroki Takeda³, Hiroko Suda², Yukihiko Inomata², Ken-ichi Yamamura¹ (Div. Developmental Genetics, IRDA, Kumamoto Univ.¹, Dept. Transplantation and Pediatric Surgery, PGSMS, Kumamoto Univ.², Div. Transgenic Technology, IRDA, Kumamoto Univ.³)
- OP07-09** 18:00-18:15 Dullard prevents excessive TGF- β signaling during endochondral ossification in mice.
Dullard は、マウス内軟骨性骨化において過剰な TGF- β シグナルを妨げる
○Tadayoshi Hayata¹, Yoichi Ezura¹, Makoto Asashima², Ryuichi Nishinakamura³, Masaki Noda¹ (Mol. Pharmacol., MRI, TMDU¹, Research Center for Stem Cell Engineering, AIST², Kidney Development, IMEG, Kumamoto Uni.³)
- OP07-10** 18:15-18:30 Foxc1 is essential for fetal forebrain angiogenesis
○Thanit Prasitsak, Sachiko Iseki (Mol. Cra. Emb., TMDU)
- OP07-11** 18:30-18:45 Birth regulates sensory map formation in the brain through serotonin signaling during development
感覚系神経回路形成における出生の機能的意義
Tomohisa Toda^{1,2}, Daigo Homma³, Hirofumi Tokuoka³, Itaru Hayakawa², Yukihiko Sugimoto⁴, Hiroshi Ichinose³, ○Hiroshi Kawasaki^{1,2} (Grad Sch Med Sci, Kanazawa Univ.¹, Grad Sch Med, Univ of Tokyo², Grad Sch Biosci Biotech, Tokyo Inst Tech.³, Grad Sch

Pharm Sci, Kumamoto Univ.⁴)

OP07-12 18:45-19:00 Temtamy Preaxial Brachydactyly Syndrome is caused by loss-of-function of CHSY1, a secreted enzyme required for bone development and digit patterning

○Tian Jing¹, Ling Ling², Shboul Mohammad², Lee Hane³, Merriman Barry³, Hamamy Hanan⁴, Reversade Bruno² (The College of Life Sciences, Northwest University¹, Institute of Medical Biology, A*STAR, Singapore², Department of Human Genetics, David Geffen School of Medicine, University of California, Los Angeles³, Geneva Foundation for Medical Education and Research⁴)

Flash Talks

FT1: Early Embryogenesis / Evolution and Development

May 28 (Wed) 13:30 ~ 14:30 Room A

Chairpersons: Daisuke Kurokawa (Univ. of Tokyo)

Hiroki Oda (JT BRH)

- FT01-01 (P150A)** 13:30-13:33 Novel white plumage mutation (*EDBRB2; mo^w*) suppresses dermal hyperpigmentation in inner organs (Fibromelanosis) in Silky chicken
ウコッケイの過剰色素産生における EDN3-EDNRB2 シグナル伝達系の関与
○Tomoko Adachi¹, Ai Shinomiya², Keiji Kinoshita³, Makoto Mizutani³, Mikiharu Nakano³, Yoichi Matsuda³, Toyoko Akiyama¹ (Dept. Biol., Keio Univ.¹, NIBB², Avian Biosci. Res. Center, Nagoya Univ.³)
- FT01-02 (P159B)** 13:33-13:36 PRL is involved in the development of mesenchymal cells in *Strongylocentrotus purpuratus*
○Li-Yi Lin¹, Han-Ru Li², Ming-Der Lin¹, Yi-Hsien Su² (MBHG, Tzu-Chi University, Taiwan¹, ICOB, Academia Sinica, Taiwan²)
- FT01-03 (P164B)** 13:36-13:39 Anterior/posterior patterning of the dorsal mesoderm in vertebrates evolved as a novelty from the ancestral chordate mesoderm by heterochronic/heterotopic shifts
脊椎動物背側中胚葉の前後軸パターン形成は祖先的脊索動物のヘテロクロニック及びヘテロトピックシフトによって進化した新規形質である。
○Takayuki Onai¹, Toshihiro Aramaki², Hidehiko Inomata³, Tamami Hirai¹, Shigeru Kuratani¹ (RIKEN CDB¹, Graduate School of Frontier Biosciences, Osaka University², Laboratory for Axial Pattern Dynamics, RIKEN Center for Developmental Biology³)
- FT01-04 (P165A)** 13:39-13:42 Mechanism and significance of Wnt protein distribution in the mouse spinal cord
マウス神経管における Wnt タンパク質分布の制御と意義
○Takuma Shinozuka^{1,2}, Ritsuko Takada², Shinji Takada^{1,2} (Dept. Basic Biology, SOKENDAI¹, NIBB²)
- FT01-05 (P166A)** 13:42-13:45 Cell surface epimorphin triggers cardiomyocyte differentiation in embryonal carcinoma P19CL6 cells
細胞膜エピモルフィンが胚性癌細胞 P19CL6 の心筋分化を引き起こす
○Takashi Tagawa, Natsumi Hagiwara, Yohei Hirai (Kwansei Gakuin Univ.)
- FT01-06 (P169A)** 13:45-13:48 The establishment of the Left-right asymmetry in sea urchin embryo
ウニ胚における左右非対称性決定機構
○Ayumi Takemoto¹, Fumie Shimono^{2,3}, Tatsuo Miyamoto⁴, Akinori Awazu¹, Hiraku Nishimori¹, Takashi Yamamoto¹, Naoaki Sakamoto¹ (Dept. of Math. and Life Sci., Hiroshima Univ.¹, Hiroshima Kokudaiji High Sch.², Edu. Proj. for Excit. Sci. Hiroshima Univ.³, Dept. of Genet. and Cell Biol., Res. Inst. for Radiation Biol. and Med., Hiroshima Univ.⁴)
- FT01-07 (P171B)** 13:48-13:52 Targeted mutagenesis of *Xenopus laevis* gene by CRISPR/Cas system
CRISPR/Cas システムによるアフリカツメガエル遺伝子への変異の導入
Mari Yamada, ○Minoru Watanabe (Fac. of Integrated Arts & Scis., The Univ. of Tokushima.)

- FT01-08 (P172B)** 13:52-13:55 Ezrin mediates the function of Inpp5e in ciliogenesis and polycystic kidney disease
 ◦Wenyan Xu, Miaomiao Jin, Fan Zhang, Hong Wang, Ying Cao (SLST, Tongji Univ.)
- FT01-09 (P142A)** 13:55-13:58 Establishing a basis for molecular studies of Madagascar ground gecko – a model case of how modern sequencing can help next-generation developmental biology
 ◦Yuichiro Hara, Miyuki Noro, Shigehiro Kuraku (GRAS, RIKEN CDB)
- FT01-10 (P144B)** 13:58-14:01 Development of pharyngeal derivatives in *Xenopus laevis*.
 アフリカツメガエルにおける鰓性器官の発生
 ◦Naoya Iimura, Hideho Uchiyama (YOKOHAMA CITY UNIV)
- FT01-11 (P145A)** 14:01-14:04 Functional interference of Pax proteins in *Drosophila* accessory gland development
 ◦Li Li, Lei Xue (SLST, Tongji Univ)
- FT01-12 (P146A)** 14:04-14:07 Single-minded gene is required for specification of ventral cell by determining on ventral midline cell fate in *Daphnia magna*
 オオミジンコ Single-minded ホモログは腹部正中線を決定し、腹部細胞の特異化に必須である
 ◦Shinichi Morita¹, Chisato Hiraga¹, Yasuhiro Shiga¹, Shinichi Tokishita¹, Taisen Iguchi², Toshihiro Ohta¹ (LEMB at TUPS¹, Div. of Mol. Env. End., NIBB²)
- FT01-13 (P148B)** 14:07-14:10 Activation of LTR retrotransposons and trophoblast-specific genes by the SRA protein Np95/Uhrf1 during murine placental development
 ◦Jafar Sharif, Kayoko Katsuyama, Yoko Mizutani-Koseki, Tomoyuki Ishikura, Takanori Hasegawa, Haruhiko Koseki (RIKEN IMS)
- FT01-14 (P149A)** 14:10-14:13 Two distinct cell populations in lamprey mandibular arch, with a revision of the heterotopic scenario of the vertebrate jaw evolution
 ヤツメウナギ顎骨弓における2つの異なる細胞集団の発見と顎進化に関する考察
 Miho Yoshimura, Daichi Suzuki, ◦Hiroshi Wada (Univ. of Tsukuba)

FT2: Morphogenesis

May 28 (Wed) 13:30 ~ 14:30 Room B

Chairpersons: Kimiko Fukuda (Tokyo Metropolitan Univ.)

Takefumi Kondo (RIKEN CDB)

- FT02-01 (P176B)** 13:30-13:33 Nano scale morphogenesis of porous extracellular matrix in *Drosophila* olfactory sensilla
 ショウジョウバエ嗅感覚毛における多孔性細胞外マトリックスのナノスケールでの形態形成
 ◦Toshiya Ando¹, Kazuyo Misaki², Shigenobu Yonemura², Shigeo Hayashi¹ (RIKEN CDB, Laboratory for Morphogenetic Signaling¹, RIKEN CDB, Electron Microscope Laboratory²)
- FT02-02 (P178A)** 13:33-13:36 Comparative analyses of RTFL peptide family on control of plant organogenesis
 ◦Pin Guo¹, Asami Yoshimura², Naoko Ishikawa³, Takahiro Yamaguchi⁴, Keiko Sakakibara², Takayuki Kohchi⁵, Youhao Guo¹, Hirokazu Tsukaya² (Wuhan University¹, Department of Biological Sciences, Graduate School of Science, University of Tokyo², Saitama Museum of Natural History³, Acel, Inc.⁴, Graduate School of Biostudies, Kyoto Univer-

sity⁵)

- FT02-03 (P179B)** 13:36-13:39 A Mathematical Model of Polygonal Cells for a Three-dimensionally Undulated Cell-sheet
3次元空間で変形自由自在の細胞シートをつくる細胞形態形成モデル
○Hisao Honda^{1,2} (Medicine, Kobe Univ.¹, RIKEN CDB²)
- FT02-04 (P181A)** 13:39-13:42 The Quail Polydactyly Mutant, HMM, shows Inactivation of SHH Signaling
多指症を発症する HMM ウズラ変異体では SHH シグナルが不活性化している
○Kazuki Kawamura¹, Yoshiyuki Matsubara¹, Mikiharu Nakano², Masaoki Tsudzuki³, Yoichi Matsuda^{2,4}, Atsushi Kuroiwa¹, Takayuki Suzuki¹ (Grad School of Sci, Nagoya Univ.¹, ABRC, Grad School of Bioag Sci, Nagoya Univ.², Grad School of Biosphere Sci, Hiroshima Univ.³, Grad School of Bioag Sci, Nagoya Univ.⁴)
- FT02-05 (P182A)** 13:42-13:45 Toward understanding the mechanisms that restricts where spicules are held up during spiculous skeleton construction of sponges
カイメンの骨片が立てられる位置を決める機構の解明に向けて
○Kouji Kishimoto, Chihiro Inui, Kiyokazu Agata, Noriko Funayama (Dept. of Biophysics, Graduate School of Science, Kyoto Univ.)
- FT02-06 (P185A)** 13:45-13:48 Characterization of polr1c in facial development related to the Treacher Collins Syndrome
○Marco CC Lau, William KF Tse (BIOL, HKBU)
- FT02-07 (P186A)** 13:48-13:52 Heterochrony in initiation of paraxial *Gdf11* expression specifies unique hindlimb positioning in tetrapods
Gdf11 発現開始タイミングのヘテロクロニーが四肢動物の後肢の位置の多様性を生み出す
○Yoshiyuki Matsubara¹, Ayumi Hattori², Yusuke Watanabe², Atsushi Sakai³, Guojun Sheng⁴, Toshihiko Ogura², Atsushi Kuroiwa¹, Takayuki Suzuki^{1,5} (Div of Biol Sci, Grad Sch of Sci, Nagoya Univ.¹, IDAC, Tohoku Univ.², The Japan Snake Institute³, RIKEN CDB⁴, JST PRESTO⁵)
- FT02-08 (P188B)** 13:52-13:55 Role of anteroposterior tissue polarity in elongation movement of *Xenopus* posterior neural tissue
ツメガエル後方神経組織の伸長運動における組織極性の働き
○Hiromasa Ninomiya (AIST)
- FT02-09 (P192B)** 13:55-13:58 Latrophilin-2 is involved in the migration and differentiation of neural crest cells.
Latrophilin-2 は神経堤細胞の遊走、分化に関与する。
○Kosuke Tanegashima¹, Marianna Suzuki^{1,2}, Kenji Suzuki¹, Tatsuo Michiue³, Takahiko Hara¹ (Stem Cell Project, Tokyo Metropol. Inst. Med. Sci.¹, Grad. Sch. of Tokyo Med. Dent. Univ.², Dep. of Life Sci., Grad. Sch. of Arts and Sci., Univ. of Tokyo³)
- FT02-10 (P194A)** 13:58-14:01 Loss-of-function analysis of deubiquitylating enzymes reveals their importance in zebrafish craniofacial development
○William Ka Fai Tse (BIOL, HKBU)
- FT02-11 (P055B)** 14:01-14:04 Mechanical properties that detect and regulate differential proliferation rate during epithelial cell competition
機械的な力という視点から、細胞競合を紐解く—“細胞が分裂速度の差を検知する仕組み”

○Alice Tsuboi¹, Shizue Ohsawa², Tatsushi Igaki², Koichi Fujimoto¹(Osaka Univ.¹, Graduate School of Biostudies, Kyoto University²)

FT02-12 (P195B) 14:04-14:07 The role of zebrafish *cdx1b* in left-right patterning
○Chun-Shiu Wu, Sheng-Ping L. Hwang, Chang-Jen Huang (IBC, NTU)

FT02-13 (P197A) 14:07-14:10 Discontinuous Transitions of Phyllotaxis: The Cases of *Thuja occidentalis* (Cupressaceae) and *Diphasiastrum digitatum* (Lycopodiaceae)
○Xiaofeng Yin^{1,2,4}, Christian Lacroix², Denis Barabe³, Roger Meicenheimer⁴ (Dept. Bio. Sci., Gra. Sch. Sci., Univ. Tokyo¹, Department of Biology, University of Prince Edward Island. Canada², Plant Biology Research Institute, Montreal Botanical Garden. Canada³, Department of Botany, Miami University. USA⁴)

FT02-14 (P198A) 14:10-14:13 Identification of ocular- or blind-side enriched genes in flounder metamorphosis
ヒラメ変態過程において有眼側および無眼側で発現する遺伝子の解析
○Hayato Yokoi, Xiaoming Wu, Yoshifumi Sakai, Tohru Suzuki (Grad Sch Agricul Sci, Tohoku Univ)

FT3: Neural Development and Behavior

May 28 (Wed) 13:30 ~ 14:30 Room C

Chairpersons: Yohei Shinmyo (Kumamoto Univ.)

Makoto Sato (Kanazawa Univ.)

FT03-01 (P061A) 13:30-13:33 Lack of $\beta 1$ integrin results in defective notochord morphogenesis with impaired convergent extension in the mouse
○Shengzhen Guo¹, T. Au¹, S. Wynn¹, D. Chan¹, A. Aszodi², R. Faessler³, K. S.E. Cheah¹ (Biochemistry, The University of Hong Kong¹, Surgery, Ludwig-Maximilians-University², Molecular Medicine, Max Planck Institute of Biochemistry³)

FT03-02 (P063B) 13:33-13:36 *Mab21l2* is required for neonatal breathing and survival
○Chung Man Chan, Wai Hung Tsang, King Lau Chow (LIFS, HKUST)

FT03-03 (P065A) 13:36-13:39 The behavior of the mandibular trigeminal nerve regulates attachment dependent of the swimming behavior in *Xenopus* tadpole
下顎三叉神経の分布様式がツメガエル幼生の遊泳行動を制御する
○Yumiko Harada¹, Megumi Takeyasu², Ayaka Ando², Ryutaro Murakami³ (Grad. Sch. Sci. Eng., Yamaguchi Univ.¹, Dept. Biol Sci. Chem., Fac. Sci., Yamaguchi Univ.², Grad. Sch. Med., Yamaguchi Univ.³)

FT03-04 (P066A) 13:39-13:42 Aging-related Neurodegeneration Dispels Male Courtship Choice in *Drosophila*
○Yujia Hu^{1,2}, Yi Han^{1,2}, Xingjun Wang^{1,2}, Lei Xue^{1,2} (SLST, Tongji Univ.¹, DIRS, Shanghai 10th People's Hospital²)

FT03-05 (P067B) 13:42-13:45 The Role of Ret in Retinal Degeneration
○I-Wen Huang¹, Meng-Lin Liao¹, Daphne Wei-Chun Kan², Nan-Kai Wang³, Chung-Liang Chien¹ (Graduate Institute of Anatomy and Cell Biology, National Taiwan University¹, Department of Obstetrics and Gynecology, College of Medicine, National Taiwan University², Department of Ophthalmology, Linkou Chang Gung Memorial Hospital³)

FT03-06 (P071B) 13:45-13:48 Maternal separation inhibits GAD67 expression in the hippocampal interneuron
母仔分離による海馬介在神経での GAD67 発現上昇阻害

○Tatsuya Katahira, Jun Motoyama (Laboratory of Developmental Neurobiology, Graduate School of Brain Science, Doshisha University)

- FT03-07 (P073A)** 13:48-13:52 Comprehensive monitoring of cell-cell contact and cell fate choice in the developing mouse neocortex
大脳新皮質における細胞間接触と細胞運命決定の網羅的モニタリング
○Takumi Kawaue¹, Ken Sago¹, Mayumi Okamoto¹, Tomoyasu Shinoda¹, Hiroshi Kiyonari², Ayano Kawaguchi¹, Takaki Miyata¹ (Cell Biology, Nagoya University, Graduate School of Medicine¹, Laboratory for Animal Resources and Genetic Engineering, Center for Developmental Biology, RIKEN²)
- FT03-08 (P074A)** 13:52-13:55 Hidden left-right differences of the developing zebrafish habenula nuclei
Guo-Tzau Wang², Chang-Huain Hsieh², Yuan-Ding Yu³, Wei-Han Lang¹, ○Yung-Shu Kuan^{1,3,4} (IBS-NTU¹, NCHC-Taiwan², IBC-Academia Sinica³, NPAS-Academia Sinica⁴)
- FT03-09 (P075B)** 13:55-13:58 Gastrointestinal dissension of neural crest cell specific Rest transcription factor CKO mice caused by the aberration of Myenteric plexus
転写調節因子 Rest の神経堤細胞特異的ノックアウトマウスにおける腸管神経叢の異常による致死的腸管拡張
○Takahiro Kunisada¹, Yasuhiro Yamada², Akira Hara³, Hitomi Aoki¹ (Dept. Tissue & Organ Development, Gifu Univ. Grad. Sch. Med.¹, CiRA, Kyoto University², Dept. Tumor Pathology, Gifu Univ. Grad. Sch. Med.³)
- FT03-10 (P076B)** 13:58-14:01 Zebrafish Adar2 Edits the Q/R site of AMPA Receptor Subunit *gria2α* transcript to Ensure Normal Development of Nervous System and Cranial Cartilages
○I-Chen Li¹, Yu-Chia Chen¹, Yi-Yun Wang², Bo-Wei Tzeng¹, Chun-Wen Ou¹, Yi-Yan Lau¹, Kan-Mai Wu¹, Tzu-Min Chan¹, Wei-Hsiang Lin¹, Sheng-Ping Hwang³, Wei-Yuan Chow^{1,2} (IMCB, NTHU¹, Institute of Systems Neuroscience, National Tsing Hua University², Institute of Cellular and Organismic Biology, Academia Sinica³)
- FT03-11 (P077A)** 14:01-14:04 Role of BMP/Smad signaling in Purkinje cell neurogenesis
○Tsz Ching Ma¹, Ka Kui Tong¹, Kin Ming Kwan^{1,2,3} (SLS, CUHK¹, COBF, CUHK², SKL, CUHK³)
- FT03-12 (P079B)** 14:04-14:07 Dissection of cerebellar neural circuitry with zebrafish Gal4 gene/enhancer trap lines
○Koji Matsuda¹, Miki Takeuchi², Kazuhide Asakawa³, Masamichi Ohkura⁴, Nobuhiko Miyasaka⁵, Yoshihiro Yoshihara⁵, Tetsutaro Hayashi⁶, Shigehiro Kuraku⁶, Koichi Kawakami³, Masahiko Hibi^{1,2}, Takashi Shimizu^{1,2} (Grad. Sch. Sci., Nagoya Univ.¹, BBC, Nagoya Univ.², NIG³, BSI, Saitama Univ.⁴, RIKEN BSI⁵, RIKEN CDB⁶)
- FT03-13 (P081A)** 14:07-14:10 FoxP1 contribute to the differentiation of the specific motoneurons committed to apoptosis in the cervical spinal cord of the developing chick embryo
発生期ニワトリ胚の頸髄において FoxP1 はアポトーシスに至る特異的な運動ニューロンの分化に関与する
○Katsuki Mukaigasa, Hiroyuki Yaginuma (Fukushima Med. Univ.)
- FT03-14 (P082A)** 14:10-14:13 Transcripts from amyloid precursor protein (APP) gene localize within a subset of axons of the optic tectum in chick embryos
アミロイド前駆体タンパク質 (APP) 遺伝子転写産物はニワトリ胚中脳視蓋の神経軸索に局在する
○Ryuji Nanayama¹, Shiho Nozaki¹, Keiko Okudaira¹, Nozomi Onodera^{1,2}, Isato Araki^{1,2} (Dept Chem Bioeng, Fac Eng, Iwate Univ¹, UGAS, Iwate Univ²)

- FT03-15 (P085A)** 14:13-14:17 An RNAi screen identifies modifiers of human APP in *Drosophila*
 ○Fei Peng, Lei Xue (SLST, Tongji Univ.)
- FT03-16 (P086A)** 14:17-14:20 Relationship between the dynamics of progenitor cells and the maintenance of pseudostratified structure of the ventricular zone
 神経前駆細胞の挙動と神経上皮構造の維持機構
 ○Tomoyasu Shinoda¹, Ryo Higuchi², Mayumi Okamoto¹, Arata Nagasaka¹, Takashi Miura³, Masaharu Nagayama², Toshihiko Fujimori⁴, Takaki Miyata¹ (Nagoya Univ. Graduate School of Medicine¹, RIES, Hokkaido Univ.², Kyusyu Univ. Graduate School of Medicine³, NIBB⁴)

FT4: Signaling in Development / Reproduction and Gametogenesis / Cell Biology

May 29 (Thu) 13:30 ~ 14:30 Room A

Chairpersons: Yoshifumi Yamaguchi (Univ. of Tokyo)

Yoshiki Hayashi (NIBB)

- FT04-01 (P141A)** 13:30-13:33 *ppk-1*/PIP5K inhibits the *cwn-2*/Wnt function to promote the correct polarity orientation of an epithelial stem cell in *C. elegans*
ppk-1/PIP5K は *cwn-2*/Wnt の機能を抑制することで線虫の表皮系幹細胞の正確な極性方向を誘導する
 ○Naoki Yoshida^{1,2}, Hitoshi Sawa^{1,2} (SOKENDAI¹, NIG²)
- FT04-02 (P137A)** 13:33-13:36 The Interplay between MT1-MMP and ADAMs in Vascular Development
 ○Hoi Leong Xavier Wong¹, Zhongjun Zhou¹ (HKU¹, The Department of Biochemistry, LKS Faculty of Medicine, The University of Hong Kong²)
- FT04-03 (P131B)** 13:36-13:39 Spatial localization of noncanonical Wnt proteins during the early *Xenopus* embryogenesis.
 アフリカツメガエル初期胚における非標準経路 Wnt 蛋白質の空間的局在
 ○Yusuke Mii^{1,2,3}, Shinji Takada^{1,2,3} (NIBB¹, OIIB², SOKENDAI³)
- FT04-04 (P129A)** 13:39-13:42 Vegetative origin of organizer cell differentiation in Dictyostelium
 細胞性粘菌の増殖期に由来するオーガナイザー細胞の分化について
 ○Satoshi Kuwana¹, Masashi Fukuzawa^{1,2} (UGAS, Iwate University¹, Hirosaki University²)
- FT04-05 (P128B)** 13:42-13:45 Preferential protein flow in cellular proliferation zone of plant leaf primordia
 葉原基の細胞増殖領域でみられるタンパク質の流れ
 ○Kensuke Kawade¹, Hirokazu Tanimoto² (RIKEN CSRS¹, Institut Jacques Monod²)
- FT04-06 (P125A)** 13:45-13:48 Genome-wide analysis of Hedgehog target genes using RNAi and RNA-seq in the spider *Parasteatoda tepidariorum*
 オオヒメグモにおける RNAi と RNA-seq を利用したヘッジホッグシグナル標的遺伝子のゲノムワイドな探索
 ○Yasuko Akiyama-Oda, Hiroki Oda (JT Biohistory Res. Hall)
- FT04-07 (P059B)** 13:48-13:52 Delta1-expressing otic precursor cells migrate within the preplacodal epithelium to form the otic placode during avian embryonic development
 鳥類胚の予定耳プラコード領域における耳プラコード前駆細胞の移動
 Hiroko Shida^{1,2}, Takumi Kawaue³, Noriko Osumi¹, Takaki Miyata³, ○Yoshio Wakamatsu¹ (Dept. Dev. Neurosci., Tohoku Univ. Grad. Sch. Med.¹, Dept. Orth. Dento. Orth., Tohoku Univ. Grad. Sch. Dent.², Dept. Anat. Cell Biol., Nagoya Univ. Grad. Sch. Med.³)

- FT04-08 (P056B)** 13:52-13:55 The Neuroprotection Effect of Erythropoietin-Overexpressed Fibroblasts on Degenerating Neurons
 ◦Yi-Chin Li, Chung-Liang Chien (Graduate Institute of Anatomy and Cell Biology, NTU)
- FT04-09 (P052B)** 13:55-13:58 Mechanochemical System for Self-organisation of Asymmetric Cell Division
 細胞の非対称分裂における自己組織化
 ◦S. Seirin Lee^{1,2}, Tatsuo Shibata³ (MLS, Hiroshima Univ.¹, RcMcD, Hiroshima Univ.², CDB, RIKEN³)
- FT04-10 (P097A)** 13:58-14:01 The gonadal development of the hybrid between white-spotted charr, *Salvelinus leucomaenis* and amago salmon, *Oncorhynchus masou ishikawae* in the tributary of Ibi River
 揖斐川水系支流におけるイワナとアマゴの交雑種の生殖腺の発達について
 ◦Taiki Niwa¹, Akihiko Goto¹, Naoki Miwa¹, Ryo Futamura¹, Takahiko Mukai², Yasunori Koya³, Yuichi Yaoi¹, Masaki Takagi¹ (Biol. Club. Gifu High Sch.¹, Fac. Region. Stud., Gifu Univ.², Fac. Edu., Gifu Univ.³)
- FT04-11 (P100B)** 14:01-14:04 Physiological relevance of frog egg apoptosis
 ◦Alexander Tokmakov¹, Sho Iguchi², Tetsushi Iwasaki¹, Yasuo Fukami^{1,2} (Res. Ctr. for Env. Genomics, Kobe Univ.¹, Grad. Sch. Sci., Kobe Univ.²)
- FT04-12 (P101A)** 14:04-14:07 Molecular dissection of Vasa function in germ plasm localization and functional germ plasm assembly in vivo
 ◦Szu-Chieh Wang¹, Hao-Jen Hsu², Gee-Way Lin³, Chun-Che Chang³, Ming-Der Lin^{1,2} (MBHG, Tzu Chi University, Taiwan¹, LS, TCU, Taiwan², Entomology, NTU, Taiwan³)
- FT04-13 (P099B)** 14:07-14:10 A revised model of gonocytes-to-spermatogonia transition in the mouse testis
 ◦Han Pin Pui^{1,2,3}, Yumiko Saga^{1,2,3} (SOKENDAI¹, Division of Mammalian Development², NIG³)
- FT04-14 (P098A)** 14:10-14:13 Bmp7 and Lef1 are the downstream effectors of androgen signaling in androgen-induced sex characteristics development in medaka
 Bmp7 と Lef1 はメダカ二次性徴発現過程においてアンドロゲンエフェクター因子として機能する
 ◦Yukiko Ogino¹, Keiji Inohaya², Eri Sumiya¹, Shinich Miyagawa¹, Gen Yamada³, Taisen Iguchi¹ (Div. Molecular Environmental Endocrinology, NIBB, SOKENDAI¹, Dept. Biological Information, Tokyuu Inst. Tech.², Dept. Developmental Genetics, Wakayama Medical Univ.³)
- FT04-15 (P096B)** 14:13-14:17 Identification of dicalcin-binding region on gp41, a *Xenopus* orthologue of ZP3
 ツメガエル卵保護膜タンパク質 ZP3 における受精調節タンパク質ダイカルシン結合部位の同定
 ◦Naofumi Miwa, Mayu Hanaue, Ken Takamatsu (Toho Univ., Dept. Physiol.)
- FT04-16 (P095B)** 14:17-14:20 Suppression of pluripotency gene together with NANOS2 is essential for male sexual differentiation in mouse germ cells
 ◦Hiroko Koike¹, Yumiko Saga^{1,2} (SOKENDAI¹, Division of Mammalian Development, National Institute of Genetics²)

FT5: Stem Cells and Regeneration

May 29 (Thu) 13:30 ~ 14:30 Room B

Chairpersons: Norito Shibata (Kyoto Univ.)

Shinji Masui (Kyoto Univ.)

- FT05-01 (P030A)** 13:30-13:33 Nanos2 organizes a post-transcriptional buffering system in mouse Spermatogonia Stem Cells
○Zhi Zhou¹, Yumiko Saga¹ (NIG¹, National Institute of Genetics², National Institute of Genetics³)
- FT05-02 (P029A)** 13:33-13:36 Cellular origin of blastema-like cells contributing to scarless skin regeneration of metamorphosed *Xenopus laevis*
ツメガエルの皮膚の完全再生に寄与する再生芽様細胞の起源
Rina Otsuka¹, Chikashi Nagayama¹, Aiko Kawasumi¹, Takashi Ariizumi², Koji Tamura¹,
○Hitoshi Yokoyama¹ (Dept. of Dev. Biol., Grad. School of Life Sci., Tohoku Univ.¹, Dept. of Bioresour. Sci., College of Agricul. Tamagawa Univ.²)
- FT05-03 (P025A)** 13:36-13:39 Comprehensive screening and identification of genes expressed preferentially in the proliferating blastema cells of the *Xenopus laevis* tadpole tails
アフリカツメガエル幼生尾の再生芽増殖細胞に選択的に発現する遺伝子の網羅的検索と解析
○Hiroshi Tsujioka¹, Takekazu Kunieda¹, Yuki Katou², Katsuhiko Shirahige², Takeo Kubo¹ (Dept. Biol. Sci., Grad. Sci. Sci., Univ. Tokyo¹, IMCB, Univ. Tokyo²)
- FT05-04 (P021A)** 13:39-13:42 Planarian homologs of cancer metastasis-related genes are involved in behaviors of their pluripotent stem cells.
プラナリア全能性幹細胞の挙動における癌転移関連遺伝子の機能解析
○Yuki Sato, Kiyokazu Agata, Norito Shibata (Dep. of Biophysics, Grad. School of Science, Kyoto Univ.)
- FT05-05 (P019B)** 13:42-13:45 Investigation of chicken early embryonic pluripotency toward a deeper understanding of its evolutionary background
ニワトリから見る多能性の進化的背景
○Shota Nakanoh, Kiyokazu Agata (Kyoto University, Science)
- FT05-06 (P014A)** 13:45-13:48 Transcriptome analysis of regenerating brain in the newt *Pleurodeles waltl*
イベリアトゲイモリにおける脳再生時のトランスクリプトーム解析
○Yuka Maeda, Makoto Kashima, Eri Kawaguchi, Shota Takemura, Takeshi Inoue, Kiyokazu Agata (Dept. of Biophys., Kyoto Univ.)
- FT05-07 (P013A)** 13:48-13:52 Specific proliferation mode of adult pluripotent stem cells for regeneration
○Hayoung Lee, Kiyokazu Agata, Norito Shibata (Dept. of Biophysics, Grad. School of Science, Kyoto Univ)
- FT05-08 (P012B)** 13:52-13:55 Heterogeneity of large RNP complexes, chromatoid bodies, in planarian adult pluripotent stem cells
プラナリア成体全能性幹細胞における大型 RNP 複合体クロマトイド小体の不均一性
○Nobuyoshi Kumagai, Makoto Kashima, Kiyokazu Agata, Norito Shibata (Div Biol. Sci. Grad. School of Sci. Kyoto Univeristy)
- FT05-09 (P008B)** 13:55-13:58 Differential Retinoic Acid Response of Stem Cell Subsets Maintains the Homeostatic Mouse Spermatogenesis

幹細胞サブセットのレチノイン酸応答性の違いが恒常的なマウス精子形成を支える

○Kanako Ikami¹, Ryo Sugimoto^{1,2}, Moe Tokue¹, Shosei Yoshida¹ (NIBB¹, EICM, Kagoshima Univ.²)

- FT05-10 (P011B)** 13:58-14:01 Activation of H3K27 methyltransferase and demethylase genes during *Xenopus* tail regeneration
○Akane Kawaguchi^{1,4}, Haruki Ochi², Norihiro Sudou³, Hajime Ogino¹ (Nagahama Inst. of Bio-Sci. and Tech.¹, Yamagata University Faculty of medicine², Tokyo Women's Medical University³, NAIST⁴)
- FT05-11 (P009A)** 14:01-14:04 Human fibroblast reprogramming by Lactic acid bacteria.
乳酸菌によるヒト繊維芽細胞の初期化
○Naofumi Ito, Rie Kawano, Kunimasa Ohta (Kumamoto University, Dev. Neurobiol.)
- FT05-12 (P024B)** 14:04-14:07 Regulatory mechanism of germline “potential stem cells” in mice
マウスの精子形成の”潜在的幹細胞”の制御機構
○Moe Tokue, Shosei Yoshida (NIBB)
- FT05-13 (P007B)** 14:07-14:10 The molecular mechanism underlying re-patterning of intermediate body regions during regeneration of the planarian *Dugesia japonica*
○Kazutaka Hosoda¹, Osmau Nishimura², Shigenobu Yazawa¹, Tetsutaro Hayashi³, Kiyokazu Agata¹, Yoshihiko Umesono⁴ (Dept. of Biophys., Kyoto Univ.¹, GCOE, Kyoto Univ.², RIKEN CDB³, Dept. of Life Systems, Inst. of Tech. and Sci., Tokushima Univ.⁴)
- FT05-14 (P005A)** 14:10-14:13 Epigenetic modification underlies recapitulation of limb-specific gene expression in *Xenopus* limb bud regeneration
ゼノパス肢芽再生におけるエピジェネティック制御による四肢特異的な遺伝子の再発現
○Shinichi Hayashi¹, Ikuo Uchiyama², Koji Tamura¹, Hitoshi Yokoyama¹ (Laboratory of Organ Morphogenesis, Tohoku University¹, Laboratory of Genome Informatics, NIBB²)
- FT05-15 (P004B)** 14:13-14:17 Mouse spermatogenic stem cell dynamics during homeostasis
マウスの恒常的精子形成を支える幹細胞動態
○Kenshiro Hara^{1,2}, Hideki Enomoto^{3,4}, Benjamin Simons⁵, Shosei Yoshida^{1,2} (NIBB¹, SOKENDAI², Kobe Univ.³, RIKEN CDB⁴, Univ. of Cambridge⁵)
- FT05-16 (P002A)** 14:17-14:20 Akhirin is involved in the neural stem cell regulation in the mouse spinal cord
○Athary Felemban^{1,2,3}, Rie Kawano¹, Xiaohong Song^{1,2}, Hideaki Tanaka^{1,2}, Kunimasa Ohta¹ (Dep. Dev. Neurobiol., Grad. Sch. Life Sci., Kumamoto Univ.¹, Kumamoto Univ., Global COE, Kumamoto Univ.², Ministry of H. Edu., Saudi Arabia³)

FT6: Organogenesis / Regulation of Gene Expression / Neural Development and Behavior

May 29 (Thu) 13:30 ~ 14:30 Room C

Chairpersons: Takanori Amano (NIG)

Yusuke Watanabe (Tohoku Univ.)

- FT06-01 (P048B)** 13:30-13:33 Ripply2-dependent negative regulation of Tbx6 is required for somitogenesis
マウスの体節形成における Tbx6 抑制因子 Ripply2 の機能解析
○Wei Zhao^{1,2}, Yumiko Saga^{1,2} (NIG¹, UTokyo²)
- FT06-02 (P053A)** 13:33-13:36 A new strategy for gene knock-in in *Xenopus laevis* using Platinum TALENs
アフリカツメガエルにおける Platinum TALEN を用いた遺伝子ノックイ

ンの新しいストラテジー

○Yuto Sakane, Tetsushi Sakuma, Miyuki Suzuki, Takashi Yamamoto, Ken-ichi Suzuki (Dept. of Math. and Life Sci., Hiroshima Univ)

- FT06-03 (P041A)** 13:36-13:39 Mouse Hammer toe (*Hm*) mutation affects a long-range *Shh* regulation
マウス Hammer toe (*Hm*) 突然変異は長距離エンハンサーによる *Shh* 発現制御に影響する
○Kousuke Mouri, Tomoko Sagai, Takanori Amano, Toshihiko Shiroishi (NIG)
- FT06-04 (P093A)** 13:39-13:42 FoxO Mediates APP-Induced AICD-Dependent Cell Death and Locomotion Defect
○Xingjun Wang, Zhiqiang Wang, Lei Xue (Key Laboratory of Signaling and Disease Research, Tongji Univ.)
- FT06-05 (P092B)** 13:42-13:45 Role of Sox9 in cerebellum neurogenesis
○Keng Ioi Vong¹, Crystal Kit-Ying Leung¹, Kin Ming Kwan^{1,2,3} (SLS, CUHK¹, COBF, CUHK², SKL, CUHK³)
- FT06-06 (P091B)** 13:45-13:48 Optogenetic analysis of escape behavior in zebrafish larvae
ゼブラフィッシュ幼生逃避行動における光遺伝学的機能解析
○Keiko Umeda, Wataru Shoji (FRIS, Tohoku Univ.)
- FT06-07 (P090A)** 13:48-13:52 Precise axogenesis of the cerebellar granule cells requires interaction between their axons and the basement membrane.
小脳顆粒細胞の正確な軸索形成には軸索と基底膜の相互作用を必要とする
○Miki Takeuchi¹, Shigenobu Yonemura², Kazuhide Asakawa³, Koichi Kawakami³, Shinji Takada⁴, Takashi Shimizu¹, Masahiko Hibi¹ (BBC, Nagoya Univ.¹, RIKEN CDB², NIG³, OIIB⁴)
- FT06-08 (P123B)** 13:52-13:55 The loss of Astrin suppresses ureteric bud branching in kidney development by apoptosis and decreased proliferation of metanephric mesenchyme (MM).
腎発生において Astrin 欠損は後腎間葉のアポトーシスと増殖不良によって尿管芽の分岐を抑制する
○Hidenori Yasuda, Yuki Tochigi, Kentaro Katayama, Hiroetsu Suzuki (Vet physiology, NVLU)
- FT06-09 (P116B)** 13:55-13:58 Elimination of an oral epithelia-specific *Shh* enhancer causes an extra pre-molar-like tooth in mouse
口腔上皮特異的な *Shh* エンハンサーの欠失による小白歯様過剰歯の形成
○Tomoko Sagai, Takanori Amano, Akiteru Maeno, Yoichi Mizushima, Toshihiko Shiroishi (Mammal. Genet., Natl. Inst. Genet.)
- FT06-10 (P115B)** 13:58-14:01 Investigation of role of a novel pancreatic beta cell gene
β細胞特異的に発現する新規遺伝子の解析
○Hisayoshi Omori, Soichiro Ogaki, Nobuaki Shiraki, Kazuhiko Kume, Shoen Kume (IMEG, Kumamoto Univ)
- FT06-11 (P112B)** 14:01-14:04 Spatiotemporal imaging of airway epithelial cells
気道上皮細胞の4Dイメージング
○Masafumi Noguchi, Mitsuru Morimoto (RIKEN CDB)
- FT06-12 (P111B)** 14:04-14:07 Theoretical Approach for the Mechanisms Underlying the Heterophylly of Lake Cress (*Rorippa aquatica*)

Rorippa aquatica における異形葉性の形成機構の理論的研究

○Akiko Nakamasu^{1,2,4}, Hokuto Nakayama^{1,2}, Nobuhiko Suematsu^{3,4}, Seisuke Kimura¹
(Facul. Life Sci., Kyo-San Univ.¹, JSPS², Grad. Sch. Adv. Math. Sci., Meiji Univ.³, MIMS,
Meiji Univ.⁴)

- FT06-13 (P108B)** 14:07-14:10 A stepwise enlargement of the mouse trachea
○Keishi Kishimoto, Mitsuru Morimoto (RIKEN CDB)
- FT06-14 (P105A)** 14:10-14:13 Self-organization of embryonic feather bud forming field in 3D culture
3次元培養での胎仔性羽毛原基形成場の自己組織化
○Kentarō Ishida, Toshiyuki Mitsui (Dept. of Phys. & Math., Coll. of Sci. & Eng., Aoyama Gakuin Univ.)
- FT06-15 (P104B)** 14:13-14:17 Dachsous-dependent polarization of Spiny-legs is critical for determining planar cell polarity orientation in *Drosophila*
Dachsous 依存的な Spiny-legs の偏在化はショウジョウバエにおける平面内細胞極性の形成において重要である
○Tomonori Ayukawa^{1,2,3}, Masakazu Akiyama⁴, Jennifer Mummery-Widmer⁵, Thomas Stoeger⁵, Junko Sasaki⁶, Juergen Knoblich⁵, Haruki Senoo³, Takehiko Sasaki^{1,2,6}, Masakazu Yamazaki^{1,2,3} (RCBS, Akita Univ¹, GCOE, Gunma Univ and Akita Univ², Dept of Cell Biol and dept of Morphol, Akita Univ Grad Sch of Med³, RIES, Hokkaido Univ⁴, IMBA⁵, Dept of Medi Biol, Akita Univ Grad Sch of Med⁶)
- FT06-16 (P103B)** 14:17-14:20 Quantification of mechanical force driving left-right asymmetric morphogenesis of the embryonic gut in *in Drosophila*
ショウジョウバエ胚消化管における左右非対称な形態を引き起こす機械的な力の定量化
○Mai Adachi¹, Naotaka Nakazawa¹, Syukei Sugita², Takeo Matsumoto², Kenji Matsuno¹
(Dept. of Biol. Sci., Osaka Univ.¹, Dept. of Mech. Eng., Nagoya Inst. of Tech.²)

Poster Sessions: May 28 (Wed)-May 29 (Thu)

P-XXXX (or B) is Poster Award candidate.

- P-001A**
(SW2-06) A classical niche for spermatogonial stem cells in the proximal tip of the seminiferous tubules in mammalian testes
曲精細管の末端部における古典的な精子幹細胞ニッチの発見
○Yoshimi Aiyama, Yoshiakira Kanai (Dept. of Vet. Anat, The Univ. of Tokyo)
- P-002A**
(FT05-16) Akhirin is involved in the neural stem cell regulation in the mouse spinal cord
○Athary Felemban^{1,2,3}, Rie Kawano¹, Xiaohong Song^{1,2}, Hideaki Tanaka^{1,2}, Kunimasa Ohta¹ (Dep. Dev. Neurobiol., Grad. Sch. Life Sci., Kumamoto Univ.¹, Kumamoto Univ., Global COE, Kumamoto Univ.², Ministry of H. Edu., Saudi Arabia³)
- P-003B** Epigenetic regulation of genes expressions via methylation on histone H3 27th lysine residue during leg regeneration.
フタホシコオロギの脚再生におけるエピジェネティックな遺伝子発現制御
○Yoshimasa Hamada¹, Tetsuya Bando², Taro Mito³, Kenji Tomioka¹, Sumihare Noji³, Hideyo Ohuchi² (OKAYAMA UNIV., Grad. Sch of Nat. Sci. and Tech.¹, OKAYAMA UNIV., Grad. Sch of Med., Dent. and Pharm. Sci.², Inst. of Tec. and Sci., Univ. of Tokushima³)
- P-004B**
(FT05-15) Mouse spermatogenic stem cell dynamics during homeostasis
マウスの恒常的精子形成を支える幹細胞動態
○Kenshiro Hara^{1,2}, Hideki Enomoto^{3,4}, Benjamin Simons⁵, Shosei Yoshida^{1,2} (NIBB¹, SOKENDAI², Kobe Univ.³, RIKEN CDB⁴, Univ. of Cambridge⁵)
- P-005A**
(FT05-14) Epigenetic modification underlies recapitulation of limb-specific gene expression in Xenopus limb bud regeneration
ゼノパス肢芽再生におけるエピジェネティック制御による四肢特異的な遺伝子の再発現
○Shinichi Hayashi¹, Ikuo Uchiyama², Koji Tamura¹, Hitoshi Yokoyama¹ (Laboratory of Organ Morphogenesis, Tohoku University¹, Laboratory of Genome Informatics, NIBB²)
- P-006A** Comparative analysis of activity of limb-specific *Shh* enhancer MFCS1 in newts and frogs
イモリとカエルを用いた四肢特異的 *Shh* エンハンサー MFCS1 の活性比較解析
○Miki Hirayama¹, Takuya Higashidate², Hitoshi Yokoyama², Koji Tamura², Takeshi Inoue¹, Kiyokazu Agata¹ (Kyoto Univ.¹, Department of Developmental Biology and Neuroscience, Graduate School of Life Science, Tohoku University²)
- P-007B**
(FT05-13) The molecular mechanism underlying re-patterning of intermediate body regions during regeneration of the planarian *Dugesia japonica*
○Kazutaka Hosoda¹, Osmou Nishimura², Shigenobu Yazawa¹, Tetsutaro Hayashi³, Kiyokazu Agata¹, Yoshihiko Umesono⁴ (Dept. of Biophys., Kyoto Univ.¹, GCOE, Kyoto Univ.², RIKEN CDB³, Dept. of Life Systems, Inst. of Tech. and Sci., Tokushima Univ.⁴)
- P-008B**
(FT05-09) Differential Retinoic Acid Response of Stem Cell Subsets Maintains the Homeostatic Mouse Spermatogenesis
幹細胞サブセットのレチノイン酸応答性の違いが恒常的なマウス精子形成を支える
○Kanako Ikami¹, Ryo Sugimoto^{1,2}, Moe Tokue¹, Shosei Yoshida¹ (NIBB¹, EICM, Kagoshima Univ.²)
- P-009A**
(FT05-11) Human fibroblast reprogramming by Lactic acid bacteria.
乳酸菌によるヒト繊維芽細胞の初期化

○Naofumi Ito, Rie Kawano, Kunimasa Ohta (Kumamoto University, Dev. Neurobiol.)

P-010A

Roles of DNA repairing factor Rad18 in germinal stem cell

生殖幹細胞における損傷修復因子 Rad18 の役割

○Natsuko Iyoda¹, Nami Ueda², Chika Sugiyama², Satoshi Tateishi⁴, Kentaro Yomogida³ (Mukogawa Women's Univ. Grad. Sch.¹, Dept. Human Environ. Scis., Mukogawa Woman's Univ.², IBS³, IMEG⁴)

P-011B
(FT05-10)

Activation of H3K27 methyltransferase and demethylase genes during *Xenopus* tail regeneration

○Akane Kawaguchi^{1,4}, Haruki Ochi², Norihiro Sudou³, Hajime Ogino¹ (Nagahama Inst. of Bio-Sci. and Tech.¹, Yamagata University Faculty of medicine², Tokyo Women's Medical University³, NAIST⁴)

P-012B
(FT05-08)

Heterogeneity of large RNP complexes, chromatoid bodies, in planarian adult pluripotent stem cells

プラナリア成体全能性幹細胞における大型 RNP 複合体クロマトイド小体の不均一性

○Nobuyoshi Kumagai, Makoto Kashima, Kiyokazu Agata, Norito Shibata (Div Biol. Sci. Grad. School of Sci. Kyoto University)

P-013A
(FT05-07)

Specific proliferation mode of adult pluripotent stem cells for regeneration

○Hayoung Lee, Kiyokazu Agata, Norito Shibata (Dept. of Biophysics, Grad. School of Science, Kyoto Univ)

P-014A
(FT05-06)

Transcriptome analysis of regenerating brain in the newt *Pleurodeles waltl*

イベリアトゲイモリにおける脳再生時のトランスクリプトーム解析

○Yuka Maeda, Makoto Kashima, Eri Kawaguchi, Shota Takemura, Takeshi Inoue, Kiyokazu Agata (Dept. of Biophys., Kyoto Univ.)

P-015B

Cooperative Bmp- and Fgf-signalling inputs convert skin wound healing to limb formation in urodele amphibians

BMP/FGF シグナルの協調的活性化により傷修復反応が四肢再生反応へと転換される

○Aki Makanae, Kazumasa Mitogawa, Akira Satoh (RCIS, Okayama Univ.)

P-016B

Comparative analysis of cartilage marker gene expression patterns in axolotl and *Xenopus* limb regeneration

アホロートルとアフリカツメガエルの四肢再生における軟骨マーカー遺伝子の発現パターン比較解析

○Kazumasa Mitogawa, Aki Makanae, Akira Satoh (RCIS, Okayama Univ)

P-017A

A pilot study: nutritional effect on newts tail regeneration

飼料の違いによるイモリの尾の再生率とカルシウムイオン濃度計測値の関係

○Toshiharu Morita¹, Keita Shimomura¹, Mitsuru Kawai¹, Tomoya Furutani¹, Masashi Yoshida¹, Naoki Matsuura², Takashi Fukui², Yoshimi Matsuura² (Department of Kyoto Cosmos, Kyoto Prefectural Sagano High School¹, Section of Science Education, Kyoto Prefectural Sagano High School²)

P-018A
(SW2-02)

PRDM14 promotes naïve pluripotency through TET-BER-mediated active demethylation

PRDM14 による TET-BER 経路を介した多能性獲得機構の解明

○Jun Nakamura, Naoki Okashita, Yoshiyuki Seki (K.G. Univ.)

P-019B
(FT05-05)

Investigation of chicken early embryonic pluripotency toward a deeper understanding of its evolutionary background

ニワトリから見る多能性の進化的背景

○Shota Nakanoh, Kiyokazu Agata (Kyoto University, Science)

P-020B

LGR4 is required for the maintenance of mammary gland

LGR4 は乳腺組織の維持に必要である

○Kazunori Oyama, Takahiro Shimoda, Yasuaki Mohri, Katsuhiko Nishimori (Lab. Mol. Biol., Grad. Sch. of Agr. Sci., Tohoku Univ.)

P-021A
(FT05-04)

Planarian homologs of cancer metastasis-related genes are involved in behaviors of their pluripotent stem cells.

プラナリア全能性幹細胞の挙動における癌転移関連遺伝子の機能解析

○Yuki Sato, Kiyokazu Agata, Norito Shibata (Dep. of Biophysics, Grad. School of Science, Kyoto Univ.)

P-022A
(SW2-09)

Transgenic imaging and tracing of the wound epidermis during zebrafish fin regeneration

ゼブラフィッシュ再生傷上皮のトランスジェニックイメージングと細胞系譜解析

○Eri Shibata¹, Kazunori Ando¹, Natsumi Horita¹, Gembu Abe², Koichi Kawakami², Akira Kudo¹, Atsushi Kawakami¹ (Tokyo tech¹, NIG²)

P-023B

Mechanisms of muscle regeneration in newts

イモリの筋再生メカニズム

○Kentaro Shimozuru, Yuki Nakayama (GSST, Kumamoto Univ.)

P-024B
(FT05-12)

Regulatory mechanism of germline “potential stem cells” in mice

マウスの精子形成の”潜在的幹細胞”の制御機構

○Moe Tokue, Shosei Yoshida (NIBB)

P-025A
(FT05-03)

Comprehensive screening and identification of genes expressed preferentially in the proliferating blastema cells of the *Xenopus laevis* tadpole tails

アフリカツメガエル幼生尾の再生芽増殖細胞に選択的に発現する遺伝子の網羅的検索と解析

○Hiroshi Tsujioka¹, Takekazu Kunieda¹, Yuki Katou², Katsuhiko Shirahige², Takeo Kubo¹ (Dept. Biol. Sci., Grad. Sch. Sci., Univ. Tokyo¹, IMCB, Univ. Tokyo²)

P-026A

Comparative studies on regeneration of the dopaminergic neuron in newts and frogs

イモリとカエルにおけるドーパミン神経再生の比較解析

○Yuko Urata, Wataru Yamashita, Yuka Maeda, Takeshi Inoue, Kiyokazu Agata (Dept. of Biophys., Grad. Sch. of Sci., Kyoto Univ.)

P-027B

Analyses of genomic imprinting during iPS cell derivation

リプログラミング過程におけるインプリンティング遺伝子の解析

○Masaki Yagi¹, Katsunori Semi^{1,2}, Akito Tanaka¹, Knut Woltjen^{1,3}, Shinya Yamanaka^{1,2,4}, Yasuhiro Yamada^{1,2} (CiRA¹, iCeMS², Hakubi Center for Advanced Research, Kyoto University³, Gladstone Institute of Cardiovascular Disease⁴)

P-028B
(SW2-11)

Distal blastema is a signaling center that directs cell proliferation during zebrafish fin regeneration

ヒレ再生で先端再生芽は細胞増殖を指令する細胞集団である

○Yuki Yokota¹, Natsumi Horita¹, Abe Gembu², Kawakami Koichi², Kudo Akira¹, Kawakami Atsushi¹ (Dept. Biol. Info., Tokyo Inst. Tech¹, National Institute of Genetics²)

P-029A
(FT05-02)

Cellular origin of blastema-like cells contributing to scarless skin regeneration of metamorphosed *Xenopus laevis*

ツメガエルの皮膚の完全再生に寄与する再生芽様細胞の起源

Rina Otsuka¹, Chikashi Nagayama¹, Aiko Kawasumi¹, Takashi Ariizumi², Koji Tamura¹, ○Hitoshi Yokoyama¹ (Dept. of Dev. Biol., Grad. School of Life Sci., Tohoku Univ.¹, Dept. of Bioresour. Sci., Col-

lege of Agricul. Tamagawa Univ.²)

P-030A Nanos2 organizes a post-transcriptional buffering system in mouse Spermatogonia Stem Cells
(FT05-01)

Zhi Zhou¹, [○]Yumiko Saga¹ (NIG¹, National Institute of Genetics², National Institute of Genetics³)

P-031B Replication-coupled passive DNA demethylation for the erasure of genome imprints in mice
(SW1-07)

ゲノムインプリント消去における受動的脱メチル化の寄与

[○]Saya Kagiwada^{1,2}, Kazuki Kurimoto^{1,2}, Fumiyoshi Ishidate³, Mitinori Saitou^{1,2,4,5} (Kyoto Univ.¹, ERATO, Kyoto², CeMI, Kyoto Univ.³, CiRA, Kyoto Univ.⁴, iCeMS, Kyoto Univ.⁵)

P-032B Otx2 expression in anterior neuroectoderm and forebrain/midbrain is directed by more than six enhancers.

Daisuke Kurokawa², [○]Tomomi Ohmura¹, Yusuke Sakurai¹, Kenichi Inoue¹, Yoko Suda¹, Shinichi Aizawa¹ (CDB, RIKEN¹, Tokyo Univ.²)

P-033A Lineage-specific highly conserved elements in avian genomes and their roles in regulation of avian-specific gene expression

鳥類特異的に高度に保存されたゲノム配列が担う鳥類特異的な遺伝子発現制御

[○]Ryohei Seki¹, Cai Li², Shiro Egawa¹, Mao Kondo¹, Tomohiko Sato¹, Jiang Hu², Luohao Xu², Hailin Pan², Naoki Irie³, Guojie Zhang², Koji Tamura¹ (Grad. Sch. of Life Sci., Tohoku Univ.¹, China National Genebank, BGI-Shenzhen², Grad. Sch. of Sci., Univ. of Tokyo³)

P-034A The impact of whole genome duplication on vertebrate evolution: Lessons from the artificially tetraploidized embryo

[○]Nanoka Suzuki¹, Hajime Ogino², Haruki Ochi¹ (Fac. of Med., Yamagata Univ.¹, Dept. of Animal Bioscience, Nagahama Inst. of Bio-Sci. and Tech.²)

P-035B Functional analyses of two KAO-NASHI genes during vertebrate organogenesis using medaka model

メダカを用いた器官形成に関わる2種の機能未知「カオナシ」遺伝子の機能解析

[○]Yasuhiro Tonoyama^{1,3}, Atsushi Shimizu², Naohiro Iwakura³, Yoshiko Shimizu¹, Nobuyoshi Shimizu^{1,3} (Adv. Res. Ctr. GSP, Keio Univ.¹, Iwate Tohoku Med. Megabank Org., Iwate Medical Univ.², Nagahama Inst. Bio-Sci. Tech.³)

P-036B Bioluminescence imaging assay of armadillo promoter activity for determining the pharmacological effect of ionomycin and 6-bromoindirubin-3-oxime in Drosophila embryogenesis

発光イメージングを用いた薬剤の作用解析：ショウジョウバエの胚発生におけるイオノマイシンおよび6-bromoindirubin-3-oximeによるarmadilloプロモーター活性への影響

[○]Ryutaro Akiyoshi, Hirobumi Suzuki (CRDC, OLYMPUS.Co.)

P-037A ROLES OF PHC2 POLYMERIZATION IN POLYCOMB REPRESSIVE FUNCTIONS

ポリコーム群複合体による遺伝子発現制御

[○]Kyoichi Isono, Mami Kumon, Haruhiko Koseki (RIKEN IMS-RCAI)

P-038A Using zebrafish to identify the novel gene which involved in regulating the huORFchop-mediated translational inhibition during ER stress

Hung-Chieh Lee, [○]Huai-Jen Tsai (IMCB, NTU)

P-039B Analysis of the mechanism to enrich a chromodomain protein MRG-1 into the primordial germ cells in *C.elegans*
(SW1-04)

線虫 *C.elegans* における、クロモドメインタンパク MRG-1 の始原生殖細胞への限局メカニズムの解析

○Takashi Miwa, Kunio Inoue, Hiroshi Sakamoto, Teruaki Takasaki (Kobe Univ.)

P-040B

The expression of zebrafish *cx36.7* gene is regulated by Gata4 in early heart development

初期心臓発生におけるゼブラフィッシュ *cx36.7* 遺伝子の発現は Gata4 によって調節されている

○Hisako Miyagi, Ippei Kasajima, Yumiko Tanaka, Keijiro Munakata, Kakon Nag, Naznin Sultana, Shigehisa Hirose, Nobuhiro Nakamura (Dep. Biol. Sci., Tokyo Tech.)

P-041A
(FT06-03)

Mouse Hammer toe (*Hm*) mutation affects a long-range *Shh* regulation

マウス Hammer toe (*Hm*) 突然変異は長距離エンハンサーによる *Shh* 発現制御に影響する

○Kousuke Mouri, Tomoko Sagai, Takanori Amano, Toshihiko Shiroishi (NIG)

P-042A

Target gene knockdown by 2', 4'-BNA/LNA Antisense oligonucleotides in zebrafish.

ゼブラフィッシュにおける 2', 4'-BNA/LNA アンチセンス核酸による標的遺伝子阻害

○Mizuki Nakaura¹, Takeshi Imanishi², Satoshi Obika², Motoyuki Itoh¹ (Grad. Sch. Pharm. Sci. Chiba Univ.¹, Graduate School of Pharmaceutical Sciences, Osaka University²)

P-043B

Identification of a cis-regulatory module for glomerular regeneration

Yuko Sasaki¹, Yuka Tamura¹, Kazuyuki Hoshijima², Hajime Ogino³, Haruki Ochi¹ (Fac. of Med., Yamagata Univ.¹, Dept. of Human Genetics, Univ. of Utah², Dept. of Animal Bioscience, Nagahama Inst. Of Bio-Sci. and Tech.³)

P-044B

Negative feedback regulation of Ripply3 for own promoter during pharyngeal arch development

咽頭弓の分節過程における Ripply3 の発現調節機構

○Tadashi Okubo¹, Shinji Takada² (Dept. of Lab. Ani. Sci., Kitasato Univ. School of Med.¹, Okazaki Inst. for Integ. Biosci., NINS²)

P-045A

Osteogenesis is regulated by mechanical stress

メカニカルストレスが骨分化に与える影響

○Eriko Sato¹, Kota Miyasaka², Toshihiko Ogura² (Dept. Dev. Neuro., Life Sci., Tohoku Univ.¹, Dept. Dev. Neurobio., IDAC., Tohoku Univ.²)

P-046A

Development of hypocretin/orexin neurons in the hypothalamus of zebrafish embryos.

ゼブラフィッシュ視床下部における hypocretin/orexin ニューロンの発生

○Minoru Takahashi, Kanako Mizumoto, Kyo Yamasu (Div. Life Sci., Grad. School Sci. Eng., Saitama Univ.)

P-047B

Multiple enhancers of the *Sox2* locus distributed within a 200 kb region in the chicken genome

ニワトリ *Sox2* 遺伝子座 200 kb における制御領域の解析

○Masanori Uchikawa, Ryuji Okamoto, Hisato Kondoh (Grad. Sch. of Frontier Biosci., Osaka Univ.)

P-048B
(FT06-01)

Ripply2-dependent negative regulation of Tbx6 is required for somitogenesis

マウスの体節形成における Tbx6 抑制因子 Ripply2 の機能解析

○Wei Zhao^{1,2}, Yumiko Saga^{1,2} (NIG¹, UTokyo²)

P-049A
(SW1-05)

Reaction-diffusion pattern in shoot apical meristem of plants

植物茎頂分裂組織における反応拡散パターン

○Hironori Fujita¹, Masayoshi Kawaguchi^{1,2} (Natl. Inst. Basic Biol.¹, Grad. Univ. Adv. Stud.²)

- P-050A**
(SW2-04) CARL: a newly developed transcriptome assembler for non-model organisms
CARL: 非モデル生物用新型 de novo トランスクリプトームアセンブラー
○Makoto Kashima, Suguru Kato, Eri Kawaguchi, Hayoung Lee, Kiyokazu Agata, Norito Shibata (DBGS, Kyoto Univ.)
- P-051B** SKL-tagging: a method for generating dominant-negative inhibitors of dimeric transcriptional factors such as Siamois and Vent
SKL タグging法: Siamois や Vent といった二量体形成型転写因子のドミナントネガティブ型を簡単に作る方法
○Yuka Sato¹, Shinya Matsukawa², Tomoyo Furukawa³, Hiroki Kuroda¹ (Faculty of Environment and Information Studies, Keio Univ.¹, Dept. of Life Sciences, Graduate School of Arts and Sciences, Univ. of Tokyo², Graduate School of Science and Technology, Shizuoka Univ.³)
- P-052B**
(FT04-09) Mechanochemical System for Self-organisation of Asymmetric Cell Division
細胞の非対称分裂における自己組織化
○S. Seirin Lee^{1,2}, Tatsuo Shibata³ (MLS, Hiroshima Univ.¹, RcMcD, Hiroshima Univ.², CDB, RIKEN³)
- P-053A**
(FT06-02) A new strategy for gene knock-in in *Xenopus laevis* using Platinum TALENs
アフリカツメガエルにおける Platinum TALEN を用いた遺伝子ノックインの新しい戦略
○Yuto Sakane, Tetsushi Sakuma, Miyuki Suzuki, Takashi Yamamoto, Ken-ichi Suzuki (Dept. of Math. and Life Sci., Hiroshima Univ.)
- P-054A** Jigsaw puzzle pattern in the epidermal cell wall of leaves
植物表皮細胞壁のジグソーパズル構造形成のメカニズム
○Hisako Takigawa-Imamura¹, Natsumaro Kutsuna², Takumi Higaki², Kae Akita², Takashi Miura¹ (Grad. Sch. Med., Kyushu Univ.¹, Grad. Sch. Frontier Sci., Univ. Tokyo²)
- P-055B**
(FT02-11) Mechanical properties that detect and regulate differential proliferation rate during epithelial cell competition
機械的な力という視点から、細胞競合を紐解く—“細胞が分裂速度の差を検知する仕組み”
○Alice Tsuboi¹, Shizue Ohsawa², Tatsushi Igaki², Koichi Fujimoto¹ (Osaka Univ.¹, Graduate School of Biostudies, Kyoto University²)
- P-056B**
(FT04-08) The Neuroprotection Effect of Erythropoietin-Overexpressed Fibroblasts on Degenerating Neurons
○Yi-Chin Li, Chung-Liang Chien (Graduate Institute of Anatomy and Cell Biology, NTU)
- P-057A** The interplay between stress granules and P-bodies during *Drosophila* oogenesis
○Chia-Ying Liu¹, Szu-Jing Huang², Ming-Der Lin^{1,2} (MBHG, Tzu Chi University, Taiwan¹, LS, Tzu Chi University, Taiwan²)
- P-058A** Mechanical stress induces cell differentiation and regulates metabolic change for energy demand
メカニカルストレスによる細胞分化と代謝制御機構の解明
○Kota Miyasaka, Eriko Sato, Toshihiko Ogura (IDAC)
- P-059B**
(FT04-07) Delta1-expressing otic precursor cells migrate within the preplacodal epithelium to form the otic placode during avian embryonic development
鳥類胚の予定耳プラコード領域における耳プラコード前駆細胞の移動
Hiroko Shida^{1,2}, Takumi Kawaue³, Noriko Osumi¹, Takaki Miyata³, ○Yoshio Wakamatsu¹ (Dept. Dev. Neurosci., Tohoku Univ. Grad. Sch. Med.¹, Dept. Orth. Dento. Orth., Tohoku Univ. Grad. Sch. Dent.², Dept. Anat. Cell Biol., Nagoya Univ. Grad. Sch. Med.³)

- P-060B** Heme acts through the Bach1b/Nrf2a-MafK pathway to regulate exocrine peptidase precursor genes in porphyric zebrafish
 °Shuqing Zhang^{1,2}, Minrui Xu^{1,2}, Jian Huang^{1,2}, Lili Tang^{1,2}, Yanqing Zhang^{1,2}, Jingyao Wu^{1,2}, Shuo Lin³, Han Wang^{1,2} (ccc¹, School of Biology & Basic Medical Sciences, Medical College, Soochow University, Suzhou, Jiangsu, China², Department of Molecular, Cell and Developmental Biology, University of California, Los Angeles, CA, USA³)
- P-061A (FT03-01)** Lack of $\beta 1$ integrin results in defective notochord morphogenesis with impaired convergent extension in the mouse
 °Shengzhen Guo¹, T. Au¹, S. Wynn¹, D. Chan¹, A. Aszodi², R. Faessler³, K. S.E. Cheah¹ (Biochemistry, The University of Hong Kong¹, Surgery, Ludwig-Maximilians-University², Molecular Medicine, Max Planck Institute of Biochemistry³)
- P-062A** Remodeling of glial assembly in *Drosophila* brain during metamorphosis
 変態期のショウジョウバエ脳におけるグリアアセンブリのリモデリング
 Kentaro Kato, °Takeshi Awasaki (Kyorin Univ. Sch. Med.)
- P-063B** *Mab21l2* is required for neonatal breathing and survival
 °Chung Man Chan, Wai Hung Tsang, King Lau Chow (LIFS, HKUST)
- P-064B** The labor-related functional characterizations of the European honeybee cephalic and thoracic exocrine glands by using large-scale proteomics
 分業に応じたセイヨウミツバチ頭部・胸部外分泌腺機能の大規模プロテオミクスを用いた解析
 °Toshiyuki Fujita¹, Hiroko Kozuka-Hata², Hiroko Ao-Kondo², Masaaki Oyama², Takeo Kubo³ (TIIMS¹, Med. Proteomics Lab., Inst. of Med., Univ. of Tokyo², Dept. of Biol. Sci., Grad. Sch. of Sci., Univ. of Tokyo³)
- P-065A (FT03-03)** The behavior of the mandibular trigeminal nerve regulates attachment dependent of the swimming behavior in *Xenopus* tadpole
 下顎三叉神経の分布様式がツメガエル幼生の遊泳行動を制御する
 °Yumiko Harada¹, Megumi Takeyasu², Ayaka Ando², Murakami Ryutarō³ (Grad. Sch. Sci. Eng., Yamaguchi Univ.¹, Dept. Biol. Sci. Chem., Fac. Sci., Yamaguchi Univ.², Grad. Sch. Med., Yamaguchi Univ.³)
- P-066A (FT03-04)** Aging-related Neurodegeneration Disrupts Male Courtship Choice in *Drosophila*
 °Yujia Hu^{1,2}, Yi Han^{1,2}, Xingjun Wang^{1,2}, Lei Xue^{1,2} (SLST, Tongji Univ.¹, DIRS, Shanghai 10th People's Hospital²)
- P-067B (FT03-05)** The Role of Ret in Retinal Degeneration
 °I-Wen Huang¹, Meng-Lin Liao¹, Daphne Wei-Chun Kan², Nan-Kai Wang³, Chung-Liang Chien¹ (Graduate Institute of Anatomy and Cell Biology, National Taiwan University¹, Department of Obstetrics and Gynecology, College of Medicine, National Taiwan University², Department of Ophthalmology, Linkou Chang Gung Memorial Hospital³)
- P-068B (SW2-01)** Strain-dependent embryonic lethality induced by flanking genes in homozygous *ST8sia2*-deficient mice
ST8sia2 ノックアウトマウスにおける系統特異的フランキンク遺伝子領域の胚性致死に及ぼす影響
 °Keisuke Ikegami¹, Kazumasa Saigoh², Mamoru Nagano¹, Susumu Kusunoki², Yasufumi Shigeyoshi¹ (Dept. Anato. Neurobiol., Kinki Univ. Facul. Med.¹, Dept. Neurology., Kinki Univ. Facul. Med.²)
- P-069A** Cancelled
- P-070A** Temporal and Spatial Regulation of Neuregulin-ErbB signaling in the developing nervous system

神経系の発達における Neuregulin-ErbB signaling の時空間的制御機構

○Aosa Kamezaki, Fuminori Sato, Kazuya Tsumagari, Atsuko Sehara-Fujisawa (IFMS, Kyoto Univ.)

P-071B
(FT03-06)

Maternal separation inhibits GAD67 expression in the hippocampal interneuron

母仔分離による海馬介在神経での GAD67 発現上昇阻害

○Tatsuya Katahira, Jun Motoyama (Laboratory of Developmental Neurobiology, Graduate School of Brain Science, Doshisha University)

P-072B

Involvement of caspase-6 in the presynaptic axon pruning of developing chick ciliary ganglion.

発達期ニワトリ胚毛様体神経節で見られるプレシナプス刈り込みへのカスパーゼ6の関与

○Hidetaka Katow¹, Ryo Egawa¹, Shoko Hososhima¹, Toru Ishizuka^{1,2}, Hiromu Yawo^{1,2,3} (Graduate school of life sciences, Tohoku Univ.¹, JST, CREST², Center of neuroscience, Tohoku University Graduate school of medicine³)

P-073A
(FT03-07)

Comprehensive monitoring of cell-cell contact and cell fate choice in the developing mouse neocortex

大脳新皮質における細胞間接触と細胞運命決定の網羅的モニタリング

○Takumi Kawau¹, Ken Sago¹, Mayumi Okamoto¹, Tomoyasu Shinoda¹, Hiroshi Kiyonari², Ayano Kawaguchi¹, Takaki Miyata¹ (Cell Biology, Nagoya University, Graduate School of Medicine¹, Laboratory for Animal Resources and Genetic Engineering, Center for Developmental Biology, RIKEN²)

P-074A
(FT03-08)

Hidden left-right differences of the developing zebrafish habenula nuclei

Guo-Tzau Wang², Chang-Huain Hsieh², Yuan-Ding Yu³, Wei-Han Lang¹, ○Yung-Shu Kuan^{1,3,4} (IBS-NTU¹, NCHC-Taiwan², IBC-Academia Sinica³, NPAS-Academia Sinica⁴)

P-075B
(FT03-09)

Gastrointestinal dissension of neural crest cell specific Rest transcription factor CKO mice caused by the aberration of Myenteric plexus

転写調節因子 Rest の神経堤細胞特異的ノックアウトマウスにおける腸管神経叢の異常による致死的腸管拡張

○Takahiro Kunisada¹, Yasuhiro Yamada², Akira Hara³, Hitomi Aoki¹ (Dept. Tissue & Organ Development, Gifu Univ. Grad. Sch. Med.¹, CiRA, Kyoto University², Dept. Tumor Pathology, Gifu Univ. Grad. Sch. Med.³)

P-076B
(FT03-10)

Zebrafish Adar2 Edits the Q/R site of AMPA Receptor Subunit *gria2* α transcript to Ensure Normal Development of Nervous System and Cranial Cartilages

○I-Chen Li¹, Yu-Chia Chen¹, Yi-Yun Wang², Bo-Wei Tzeng¹, Chun-Wen Ou¹, Yi-Yan Lau¹, Kan-Mai Wu¹, Tzu-Min Chan¹, Wei-Hsiang Lin¹, Sheng-Ping Hwang³, Wei-Yuan Chow^{1,2} (IMCB, NTHU¹, Institute of Systems Neuroscience, National Tsing Hua University², Institute of Cellular and Organismic Biology, Academia Sinica³)

P-077A
(FT03-11)

Role of BMP/Smad signaling in Purkinje cell neurogenesis

○Tsz Ching Ma¹, Ka Kui Tong¹, Kin Ming Kwan^{1,2,3} (SLS, CUHK¹, COBE, CUHK², SKL, CUHK³)

P-078A

Spatiotemporal expression patterns of novel candidate genes for axonal guidance in the mouse head

新規軸索ガイド候補分子のマウス頭部における発現様式

○Tomoyuki Masuda¹, Masahiko Taniguchi², Chie Sakuma³, Hideki Ohmomo⁴, Shuichi Ueda⁵, Hiroyuki Yaginuma³ (Dept of Neurobiol, Univ of Tsukuba Sch of Med¹, Dept of Biochem, Sapporo Med Univ Sch of Med², Dept of Anat, Fukushima Med Univ Sch of Med³, Iwate Tohoku Med Bank Orga, Iwate Med Univ⁴, Dept of Histol Neurobiol, Dokkyo Med Univ Sch of Med⁵)

P-079B
(FT03-12)

Dissection of cerebellar neural circuitry with zebrafish Gal4 gene/enhancer trap lines

○Koji Matsuda¹, Miki Takeuchi², Kazuhide Asakawa³, Masamichi Ohkura⁴, Nobuhiko Miyasaka⁵, Yoshi-

hiro Yoshihara⁵, Tetsutaro Hayashi⁶, Shigehiro Kuraku⁶, Koichi Kawakami³, Masahiko Hibi^{1,2}, Takashi Shimizu^{1,2} (Grad. Sch. Sci., Nagoya Univ.¹, BBC, Nagoya Univ.², NIG³, BSI, Saitama Univ.⁴, RIKEN BSI⁵, RIKEN CDB⁶)

P-080B Different combinations of Notch ligands and receptors regulate V2 interneuron progenitor proliferation and V2a /V2b cell fate determination.

Sayumi Okigawa², [○]Takamasa Mizoguchi¹, Makoto Okanao², Haruna Tanaka¹, Miho Isoda², Yun-Jin Jiang³, Maximiliano Susuter⁴, Shinichi Higashijima⁵, Koichi Kawakami⁴, Motoyuki Itoh^{1,2} (Grad. Sch. of Pharm. Sci., Chiba Univ.¹, Grad. Sch. of Sci., Nagoya Univ.², IMGM, NHRI³, NIG⁴, Okazaki Inst. Integr. Biosci.⁵)

P-081A
(FT03-13) FoxP1 contribute to the differentiation of the specific motoneurons committed to apoptosis in the cervical spinal cord of the developing chick embryo

発生期ニワトリ胚の頸髄において FoxP1 はアポトーシスに至る特異的な運動ニューロンの分化に参与する

[○]Katsuki Mukaigasa, Hiroyuki Yaginuma (Fukushima Med. Univ.)

P-082A
(FT03-14) Transcripts from amyloid precursor protein (APP) gene localize within a subset of axons of the optic tectum in chick embryos

アミロイド前駆体タンパク質 (APP) 遺伝子転写産物はニワトリ胚中脳視蓋の神経軸索に局在する

[○]Ryuji Nanayama¹, Shiho Nozaki¹, Keiko Okudaira¹, Nozomi Onodera^{1,2}, Isato Araki^{1,2} (Dept Chem Bioeng, Fac Eng, Iwate Univ¹, UGAS, Iwate Univ²)

P-083B Mechanical stress influences the behavior of cortical progenitor cells

力学的刺激が大脳神経前駆細胞の挙動に与える影響

[○]Mayumi Okamoto, Tomoyasu Shinoda, Arata Nagasaka, Takaki Miyata (Department of Anatomy and Cell Biology, Nagoya University)

P-084B
(SW2-10) Axonal mRNAs encoding transcription factors in the tectum of chick embryos

ニワトリ胚中脳視蓋で見られる転写因子をコードする軸索性 mRNA

[○]Nozomi Onodera^{1,2}, Hiroshi Nakata², Miwa Watanabe³, Yasuhiro Itoh⁴, Isato Araki^{1,2} (UGAS, Iwate Univ¹, Dept Chem Bioeng, Fac Eng, Iwate Univ², Tech Div, Fac Eng, Iwate Univ³, Grad Sch Pharm Sci, Univ Tokyo⁴)

P-085A
(FT03-15) An RNAi screen identifies modifiers of human APP in Drosophila

[○]Fei Peng, Lei Xue (SLST, Tongji Univ.)

P-086A
(FT03-16) Relationship between the dynamics of progenitor cells and the maintenance of pseudostratified structure of the ventricular zone

神経前駆細胞の挙動と神経上皮構造の維持機構

[○]Tomoyasu Shinoda¹, Ryo Higuchi², Mayumi Okamoto¹, Arata Nagasaka¹, Takashi Miura³, Masaharu Nagayama², Toshihiko Fujimori⁴, Takaki Miyata¹ (Nagoya Univ. Graduate School of Medicine¹, RIES, Hokkaido Univ.², Kyusyu Univ. Graduate School of Medicine³, NIBB⁴)

P-087B
(SW2-05) Semaphorin/plexin signaling regulates the development of the amygdala-BNST network

セマフォリン/プレキシシン シグナルは扁桃核と分界条床核との接続を制御する

[○]Fumikazu Suto¹, Masahumi Kawaguchi¹, Noriko Osumi², Noritaka Ichinohe¹ (NINS, NCNP¹, Div. Dev. Neurosci., Tohoku Univ. Grad. Sch. of Med.²)

P-088B
(SW2-08) Establishment of neural circuit by interaction between cells of different origins

由来の異なる細胞同士の相互作用による神経回路の形成機構

[○]Takumi Suzuki¹, Masako Kaido¹, Rie Takayama¹, Makoto Sato^{1,2} (Brain/Liver Center, Kanazawa Univ¹, PRESTO, JST²)

- P-089A** Visualization of zebrafish rhombomere-boundary formation using a modified multiple embryo-mounting method and short-time interval time-lapse confocal microscopy
ゼブラフィッシュ後脳ロンボマ境界形成の短時間間隔タイムラプスイメージング解析
○Masanori Takahashi^{1,2,3}, Qiling Xu³, David Wilkinson³ (Div. of Biol. Cent. for Mol. Med. Jichi Med. Univ.¹, Grad. Sch. of Med. Jichi Med. Univ.², Div. of Dev. Neurobiol. MRC NIMR³)
- P-090A**
(FT06-07) Precise axogenesis of the cerebellar granule cells requires interaction between their axons and the basement membrane.
小脳顆粒細胞の正確な軸索形成には軸索と基底膜の相互作用を必要とする
○Miki Takeuchi¹, Shigenobu Yonemura², Kazuhide Asakawa³, Koichi Kawakami³, Shinji Takada⁴, Takashi Shimizu¹, Masahiko Hibi¹ (BBC, Nagoya Univ.¹, RIKEN CDB², NIG³, OIIB⁴)
- P-091B**
(FT06-06) Optogenetic analysis of escape behavior in zebrafish larvae
ゼブラフィッシュ幼生逃避行動における光遺伝学的機能解析
○Keiko Umeda, Wataru Shoji (FRIS, Tohoku Univ.)
- P-092B**
(FT06-05) Role of Sox9 in cerebellum neurogenesis
○Keng Ioi Vong¹, Crystal Kit-Ying Leung¹, Kin Ming Kwan^{1,2,3} (SLS, CUHK¹, COBF, CUHK², SKL, CUHK³)
- P-093A**
(FT06-04) FoxO Mediates APP-Induced AICD-Dependent Cell Death and Locomotion Defect
○Xingjun Wang, Zhiqiang Wang, Lei Xue (Key Laboratory of Signaling and Disease Research, Tongji Univ.)
- P-094A**
(SW2-07) Conserved roles of PRDM14 orthologues in DNA demethylation and pluripotency in embryonic stem cells
種間比較を用いた PRDM14 の機能解析
○Shota Hashimoto, Akari Shirakami, Yoshiyuki Seki (K.G. Univ)
- P-095B**
(FT04-16) Suppression of pluripotency gene together with NANOS2 is essential for male sexual differentiation in mouse germ cells
○Hiroko Koike¹, Yumiko Saga^{1,2} (SOKENDAI¹, Division of Mammalian Development, National Institute of Genetics²)
- P-096B**
(FT04-15) Identification of dicalcin-binding region on gp41, a *Xenopus* orthologue of ZP3
ツメガエル卵保護膜タンパク質 ZP3 における受精調節タンパク質ダイカルシン結合部位の同定
○Naofumi Miwa, Mayu Hanaue, Ken Takamatsu (Toho Univ., Dept. Physiol.)
- P-097A**
(FT04-10) The gonadal development of the hybrid between white-spotted charr, *Salvelinus leucomaenis* and amago salmon, *Oncorhynchus masou ishikawae* in the tributary of Ibi River
揖斐川水系支流におけるイワナとアマゴの交雑種の生殖腺の発達について
○Taiki Niwa¹, Akihiko Goto¹, Naoki Miwa¹, Ryo Futamura¹, Takahiko Mukai², Yasunori Koya³, Yuichi Yanoi¹, Masaki Takagi¹ (Biol. Club. Gifu High Sch.¹, Fac. Region. Stud., Gifu Univ.², Fac. Edu., Gifu Univ.³)
- P-098A**
(FT04-14) Bmp7 and Lef1 are the downstream effectors of androgen signaling in androgen-induced sex characteristics development in medaka
Bmp7 と Lef1 はメダカ二次性徴発現過程においてアンドロゲンエフェクター因子として機能する
○Yukiko Ogino¹, Keiji Inohaya², Eri Sumiya¹, Shinich Miyagawa¹, Gen Yamada³, Taisen Iguchi¹ (Div. Molecular Environmental Endocrinology, NIBB, SOKENDAI¹, Dept. Biological Information, Tokyuu Inst. Tech.², Dept. Developmental Genetics, Wakayama Medical Univ.³)

- P-099B**
(FT04-13) A revised model of gonocytes-to-spermatogonia transition in the mouse testis
○Han Pin Pui^{1,2,3}, Yumiko Saga^{1,2,3} (SOKENDAI¹, Division of Mammalian Development², NIG³)
- P-100B**
(FT04-11) Physiological relevance of frog egg apoptosis
○Alexander Tokmakov¹, Sho Iguchi², Tetsushi Iwasaki¹, Yasuo Fukami^{1,2} (Res. Ctr. for Env. Genomics, Kobe Univ.¹, Grad. Sch. Sci., Kobe Univ.²)
- P-101A**
(FT04-12) Molecular dissection of Vasa function in germ plasm localization and functional germ plasm assembly in vivo
○Szu-Chieh Wang¹, Hao-Jen Hsu², Gee-Way Lin³, Chun-Che Chang³, Ming-Der Lin^{1,2} (MBHG, Tzu Chi University, Taiwan¹, LS, TCU, Taiwan², Entomology, NTU, Taiwan³)
- P-102A** Testicular Zinc Finger Transcription Factor Zfp318 Deficiency Results in Defective Meiosis of Spermatogenesis in Mice
マウス精巣特異的転写因子 Zfp318 欠失による精子形成時の減数分裂異常について
○Kaoru Yoshida¹, Masamichi Ishizuka², Eri Ohtsuka², Mirei Odaka², Hiroataka Ohshima², Norihisa Tamura², Norihisa Sako³, Tadashi Baba⁴, Shin-ichi Kashiwabara⁴, Masaru Okabe⁵, Junko Noguchi⁶, Hiromi Hagiwara^{2,3} (BME Center, Toin Univ. of Yokohama¹, Dept. of Biol. Sci., Tokyo Inst. Tech.², Dept. of Biomed. Engin., Toin Univ. of Yokohama³, Grad. Sc. of Life & Environ. Sci., Univ. of Tsubaki⁴, Genome Information Research Center, RIMD, Osaka Univ.⁵, Germ Cell Conservation Laboratory, NIAS⁶)
- P-103B**
(FT06-16) Quantification of mechanical force driving left-right asymmetric morphogenesis of the embryonic gut in *in Drosophila*
ショウジョウバエ胚消化管における左右非対称な形態を引き起こす機械的な力の定量化
○Mai Adachi¹, Naotaka Nakazawa¹, Syukei Sugita², Takeo Matsumoto², Kenji Matsuno¹ (Dept. of Biol. Sci., Osaka Univ.¹, Dept. of Mech. Eng., Nagoya Inst. of Tech.²)
- P-104B**
(FT06-15) Dachshous-dependent polarization of Spiny-legs is critical for determining planar cell polarity orientation in *Drosophila*
Dachshous 依存的な Spiny-legs の偏在化はショウジョウバエにおける平面内細胞極性の形成において重要である
○Tomonori Ayukawa^{1,2,3}, Masakazu Akiyama⁴, Jennifer Mummery-Widmer⁵, Thomas Stoeger⁵, Junko Sasaki⁶, Juergen Knoblich⁵, Haruki Senoo³, Takehiko Sasaki^{1,2,6}, Masakazu Yamazaki^{1,2,3} (RCBS, Akita Univ.¹, GCOE, Gunma Univ and Akita Univ², Dept of Cell Biol and dept of Morphol, Akita Univ Grad Sch of Med³, RIES, Hokkaido Univ⁴, IMBA⁵, Dept of Medi Biol, Akita Univ Grad Sch of Med⁶)
- P-105A**
(FT06-14) Self-organization of embryonic feather bud forming field in 3D culture
3次元培養での胎仔性羽毛原基形成場の自己組織化
○Kentaro Ishida, Toshiyuki Mitsui (Dept. of Phys. & Math., Coll. of Sci. & Eng., Aoyama Gakuin Univ.)
- P-106A** Expression of *Eph/ephrin* family genes in the heart tube and proepicardium of the chick embryo
ニワトリ胚心臓および心外膜原基における *Eph/ephrin* ファミリー遺伝子の発現
○Yasuo Ishii, Kiyoe Fujimoto, Wang Zi, Sadao Yasugi (Fac. Life. Sci., Kyoto Sangyo Univ.)
- P-107B**
(SW1-03) Cadherin-7 joins dorsal-ventral patterning of the chick embryonic spinal cord through sonic hedgehog signaling
カドヘリン-7はソニックヘッジホッグシグナルを介し、ニワトリ胚神経管の背腹軸に沿った形態形成に関与している
○Rie Kawano, Kunimasa Ohta, Naofumi Ito (Dev. Neurobio. Kumamoto University)

- P-108B**
(FT06-13) A stepwise enlargement of the mouse trachea
○Keishi Kishimoto, Mitsuru Morimoto (RIKEN CDB)
- P-109A** Tissue reconstruction of myocardium during *Xenopus laevis* metamorphosis
アフリカツメガエルの変態期における心筋の組織再構築
○Manami Kobayashi, Misa Sugiura, Tsutomu Kinoshita (Dept. Life Sci. Fac. Sci. Rikkyo Univ.)
- P-110A** Role of HOX genes in the pattern formation of *Drosophila* midgut
ショウジョウバエ中腸のパターン形成における HOX 遺伝子群の役割
Yuichi Yoshimura¹, Yumiko Harada², Keita Fujimoto¹, Masahiko Arishige¹, ○Ryutaro Murakami¹ (Grad. Sch. Med., Yamaguchi Univ.¹, Grad. Sch. Sci. Eng., Yamaguchi Univ.,²)
- P-111B**
(FT06-12) Theoretical Approach for the Mechanisms Underlying the Heterophylly of Lake Cress (*Rorippa aquatica*)
Rorippa aquatica における異形葉性の形成機構の理論的研究
○Akiko Nakamasu^{1,2,4}, Hokuto Nakayama^{1,2}, Nobuhiko Suematsu^{3,4}, Seisuke Kimura¹ (Facul. Life Sci., Kyo-San Univ.¹, JSPS², Grad. Sch. Adv. Math. Sci., Meiji Univ.³, MIMS, Meiji Univ.⁴)
- P-112B**
(FT06-11) Spatiotemporal imaging of airway epithelial cells
気道上皮細胞の 4D イメージング
○Masafumi Noguchi, Mitsuru Morimoto (RIKEN CDB)
- P-113A** A novel marker identifying the genuine population of the definitive endoderm cells
真の胚性内胚葉細胞外表面マーカーの同定
○Soichiro Ogaki, Mayu Moroka, Nobuaki Shiraki, Shoen Kume (Kumamoto Univ IMEG Dept. of Stem Cell Biol.)
- P-114A** Hepatocyte Growth Factor signaling is required for melanocyte incorporation in the non-sensory structures of mammalian cochlea
蝸牛血管条形成における HGF シグナルの役割
Shumei Shibata², Toru Miwa¹, Hsiao-Huei Wu³, Pat Levitt³, ○Takahiro Ohyama¹ (KSOM, USC¹, Oto, Med Kyushu Univ², SRI, CHLA³)
- P-115B**
(FT06-10) Investigation of role of a novel pancreatic beta cell gene
β 細胞特異的に発現する新規遺伝子の解析
○Hisayoshi Omori, Soichiro Ogaki, Nobuaki Shiraki, Kazuhiko Kume, Shoen Kume (IMEG, Kumamoto Univ)
- P-116B**
(FT06-09) Elimination of an oral epithelia-specific *Shh* enhancer causes an extra premolar-like tooth in mouse
口腔上皮特異的な *Shh* エンハンサーの欠失による小臼歯様過剰歯の形成
○Tomoko Sagai, Takanori Amano, Akiteru Maeno, Yoichi Mizushina, Toshihiko Shiroishi (Mammal. Genet., Natl. Inst. Genet.)
- P-117A** TALEN mediated knockout zebrafish reveals the critical function of *r-spondin2* in the fin and vertebral skeletogenesis
TALEN 法で作製した *r-spondin2*- ノックアウトゼブラフィッシュは鰭と脊椎骨に異常を示す
Tatsumi Yoshinari¹, Hayato Yokoi¹, Masaru Matsuda², ○Tohru Suzuki¹ (Grad. Sch. of Agric. Sci., Tohoku Univ.¹, Ctr Biosci Res Edu, Utsunomiya Univ²)
- P-118A**
(SW1-09) Celf1 Regulates Endoderm Proliferation and Migration In Zebrafish
ゼブラフィッシュ胚における RNA 結合タンパク celf1 の内胚葉由来の器官形成に対する制御機構の解明

○Naoyuki Tahara, Yasumasa Bessho, Takaaki Mtatsui (NAIST)

P-119B Analysis of morphological changes of epidermal cells producing *C. elegans* sensory rays
C. elegans の感覚器を形成する表皮細胞の形態変化解析

○Shin Takagi, Hiroki Tanaka, Ayana Kobayashi (Div. of Biol. Sci. Nagoya Univ.)

P-120B Analysis of distribution of Wt1 expression cell in diaphragm development

横隔膜発生時における Wt1 発現細胞の分布解析

○Norifumi Tatsumi, Masataka Okabe (Dept. of Anat. Jikei Univ. Sch. of Med.)

P-121A
(SW1-08) Unexpected role of blood platelets in lung development depending on a novel platelet activation receptor, CLEC-2

血小板が正常な肺発生を可能にする - 新規血小板活性化受容体 CLEC-2 の機能解析 -

○Nagaharu Tsukiji¹, Osamu Inoue², Shogo Tamura¹, Toshiaki Shirai¹, Katsue Inoue¹, Yukio Ozaki¹ (Department of Clinical and Laboratory Medicine, Faculty of Medicine, University of Yamanashi¹, Infection Control Office, University of Yamanashi Hospital, Faculty of Medicine, University of Yamanashi²)

P-122A A regulatory mechanism of skeletal tissue size in the limb

○Yo-ichi Yamamoto-Shiraishi, Atsushi Kuroiwa (Div. of Biol.Sci., Grad. Sch. of Sci., Nagoya Univ.)

P-123B
(FT06-08) The loss of Astrin suppresses ureteric bud branching in kidney development by apoptosis and decreased proliferation of metanephric mesenchyme (MM).

腎発生において Astrin 欠損は後腎間葉のアポトーシスと増殖不良によって尿管芽の分岐を抑制する

○Hidenori Yasuda, Yuki Tochigi, Kentaro Katayama, Hiroetsu Suzuki (Vet physiology, NVLU)

P-124B Zinc finger transcription factor sp7 is essential for zebrafish bone development

Pengfei Niu, ○Zhaomin Zhong, Guodong Huang, Shuhao Xu, Mingyong Wang, Yi Hou, Yilin Yan, Han Wang (CCC, Soochow Univ.)

P-125A
(FT04-06) Genome-wide analysis of Hedgehog target genes using RNAi and RNA-seq in the spider *Parasteatoda tepidariorum*

オオヒメグモにおける RNAi と RNA-seq を利用したヘッジホッグシグナル標的遺伝子のゲノムワイドな探索

○Yasuko Akiyama-Oda, Hiroki Oda (JT Biohistory Res. Hall)

P-126A *Xenopus* Ubiquitin carboxy-terminal hydrolase 37 (XUch37) is required for the mesoderm patterning by regulating the formation of Tcf1/β-catenin complex

Wonhee Han, ○Jin-Kwan Han (POSTECH)

P-127B Cancelled

P-128B
(FT04-05) Preferential protein flow in cellular proliferation zone of plant leaf primordia

葉原基の細胞増殖領域でみられるタンパク質の流れ

○Kensuke Kawade¹, Hirokazu Tanimoto² (RIKEN CSRS¹, Institut Jacques Monod²)

P-129A
(FT04-04) Vegetative origin of organizer cell differentiation in *Dictyostelium*

細胞性粘菌の増殖期に由来するオーガナイザー細胞の分化について

○Satoshi Kuwana¹, Masashi Fukuzawa^{1,2} (UGAS, Iwate University¹, Hirosaki University²)

P-130A Manipulation of gene expression by localized heat shock by infrared laser in *Drosophila*

○Guangxia Miao^{1,2}, Shigeo Hayashi^{1,2} (RIKEN CDB¹, Department of Biology, Kobe University Graduate School of Science²)

- P-131B**
(FT04-03) Spatial localization of noncanonical Wnt proteins during the early *Xenopus* embryogenesis.
アフリカツメガエル初期胚における非標準経路 Wnt 蛋白質の空間的局在
○Yusuke Mii^{1,2,3}, Shinji Takada^{1,2,3} (NIBB¹, OIIB², SOKENDAI³)
- P-132B** Secreted decoy of insulin-receptor (SDR) positively regulates insulin/IGF signaling for neuroblast re-activation in *Drosophila* brain
ショウジョウバエ分泌型おとりインスリン受容体 SDR は、脳内のインスリンシグナルを正に制御することで神経幹細胞の増殖を誘導する
Takayuki Yamada, Naoki Okamoto, ○Takashi Nishimura (RIKEN CDB)
- P-133A**
(SW1-10) Analysis of the Delta signaling as the reverse signaling of Notch during mouse development
マウス胚発生における Notch とは逆方向の Delta シグナル解析
○Yusuke Okubo¹, Katsuhide Igarashi¹, Yumiko Saga², Jun Kanno¹ (Div. of Cell. and Mol. Toxicol., NIHS¹, Div. of Mam. Dev., NIG²)
- P-134A**
(SW1-02) Apolipoprotein A-I is involvement in the liver regionalization via control BMP signaling.
Apolipoprotein A-I は BMP シグナルの調節を介して肝臓の領域化に働く。
○Satoru Shimura, Hiroyuki Kawahara, Kimiko Fukuda (Dept. Biol. Sci., Tokyo Metr. Univ.)
- P-135B** Metabolic profiling of brown adipose tissue during mouse development
マウス成長過程における褐色脂肪組織のメタボローム解析
○Hitomi Takada¹, Yasu-yuki Kida¹ (AIST¹, AIST²)
- P-136B** Non-neuronal acetylcholine as an endogenous regulator of proliferation and differentiation of *Lgr5*-positive stem cells in mice
腸幹細胞システムを制御する非神経性アセチルコリンの役割
○Toshio Takahashi¹, Hiroe Ohnishi², Yuki Sugiura³, Kurara Honda³, Makoto Suematsu³, Takashi Kawasaki², Tomonori Deguchi², Takeshi Fujii⁴, Kaoru Orihashi⁵, Yoshitaka Hippo⁵, Takehiro Watanabe¹, Tohru Yamagaki¹, Shunsuke Yuba² (Suntory Found. for Life Sci.¹, AIST², DBSM, Keio Univ.³, DPFPS, Doshisha Women's College⁴, DCDS, Natl. Cancer Res. Inst.⁵)
- P-137A**
(FT04-02) The Interplay between MT1-MMP and ADAMs in Vascular Development
Hoi Leong Xavier Wong, ○Zhongjun Zhou (HKU)
- P-138A** Root-knot nematodes utilize plant CLE signaling for infection process
サツマイモネコブ線虫は植物 CLE シグナル経路を利用して寄生する
○Yasuka Yamaguchi, Yumi Kanemaru, Chika Ejima, Shinichiro Sawa (GSST, Kumamoto Univ.)
- P-139B** The role of heparan sulfate proteoglycan nanostructures in morphogen gradient formation and signaling reception
○Takayoshi Yamamoto¹, Yusuke Mii², Masanori Taira¹ (Lab. of Mol. Biol., Dept. of Biol. Scis., Grad. Sch. of Sci., Univ. of Tokyo¹, Div. of Mol. and Dev. Biol., NIBB²)
- P-140B** Interplay between ER stress and hypoxia pathways in chondrocytes
○Qing Yao, Wilson Chan, Vivian Ng, Zhijia Tan, Kwok Tsang, Kathryn Cheah, Danny Chan (Department of Biochemistry, Faculty of Medicine, The University of Hong Kong)
- P-141A**
(FT04-01) *ppk-1*/PIP5K inhibits the *cwn-2*/Wnt function to promote the correct polarity orientation of an epithelial stem cell in *C. elegans*
ppk-1/PIP5K は *cwn-2*/Wnt の機能を抑制することで線虫の表皮系幹細胞の正確な極性方向を誘導する
○Naoki Yoshida^{1,2}, Hitoshi Sawa^{1,2} (SOKENDAI¹, NIG²)

- P-142A
(FT01-09)** Establishing a basis for molecular studies of Madagascar ground gecko – a model case of how modern sequencing can help next-generation developmental biology
 ◦Yuichiro Hara, Miyuki Noro, Shigehiro Kuraku (GRAS, RIKEN CDB)
- P-143B** Expression profile of POU family class V transcription factor in the ontogeny of *Cynops pyrrhogaster*.
 アカハライモリの個体発生における POU ファミリークラス V 転写因子の発現プロファイルの解析
 ◦Shun Hasegawa, Yuuki Ootani, Tsutomu Kinoshita (Dept. Life Sci. Rikkyo Univ.)
- P-144B
(FT01-10)** Development of pharyngeal derivatives in *Xenopus laevis*.
 アフリカツメガエルにおける鰓性器官の発生
 ◦Naoya Imura, Hideho Uchiyama (YOKOHAMA CITY UNIV)
- P-145A
(FT01-11)** Functional interference of Pax proteins in *Drosophila* accessory gland development
 ◦Li Li, Lei Xue (SLST, Tongji Univ)
- P-146A
(FT01-12)** Single-minded gene is required for specification of ventral cell by determining on ventral midline cell fate in *Daphnia magna*
 オオミジンコ Single-minded ホモログは腹部正中線を決定し、腹部細胞の特異化に必須である
 ◦Shinichi Morita¹, Chisato Hiraga¹, Yasuhiro Shiga¹, Shinichi Tokishita¹, Taisen Iguchi², Toshihiro Ohta¹ (LEMB at TUPS¹, Div. of Mol. Env. End., NIBB²)
- P-147B** Hox genes of the hagfish and the early genomic evolution of vertebrates
 ◦Juan Pascual-Anaya¹, Antonio Perez-Pulido^{2,3}, Fumiaki Sugahara⁴, Shigeru Kuratani¹ (RIKEN CDB¹, CABD², UPO-CSIC-JA³, HCM⁴)
- P-148B
(FT01-13)** Activation of LTR retrotransposons and trophoblast-specific genes by the SRA protein Np95/Uhrf1 during murine placental development
 ◦Jafar Sharif, Kayoko Katsuyama, Yoko Mizutani-Koseki, Tomoyuki Ishikura, Takanori Hasegawa, Haruhiko Koseki (RIKEN IMS)
- P-149A
(FT01-14)** Two distinct cell populations in lamprey mandibular arch, with a revision of the heterotopic scenario of the vertebrate jaw evolution
 ヤツメウナギ顎骨弓における 2 つの異なる細胞集団の発見と顎進化に関する考察
 Miho Yoshimura, Daichi Suzuki, ◦Hiroshi Wada (Univ. of Tsukuba)
- P-150A
(FT01-01)** Novel white plumage mutation (*EDBRB2; mo^w*) suppresses dermal hyperpigmentation in inner organs (Fibromelanosis) in Silky chicken
 ウコッケイの過剰色素産生における EDN3-EDNRB2 シグナル伝達系の関与
 ◦Tomoko Adachi¹, Ai Shinomiya², Keiji Kinoshita³, Makoto Mizutani³, Mikiharu Nakano³, Yoichi Matsuda³, Toyoko Akiyama¹ (Dept. Biol., Keio Univ.¹, NIBB², Avian Biosci. Res. Center, Nagoya Univ.³)
- P-151B** Involvement of ERK MAPK signaling in the expression of mesoderm genes in embryonic stem cells
 ES 細胞における中胚葉遺伝子発現への ERK MAPK シグナル経路の関与
 ◦Yuhei Ashida, Eisuke Nishida (Dept. of Cell and Dev. Biol., Grad. Sch. of Biostudies, Kyoto Univ)
- P-152B** Disruption of human XLID gene results in deficiency of early extra-embryonic progenitor maintenance
 ◦Chun-Yu Chen, I-Shing Yu, Yu-Chen Hsu, Chien-Yu Lin, Ming-Shian Tsai, Shu-Whea Lin (CLSMB, NTU)

- P-153A** Functional analyses of a novel insulin-like factor
 新規インスリン様因子の機能解析
 °Yoshikazu Haramoto¹, Shuji Takahashi², Yasuko Onuma¹, Yuzuru Ito¹, Makoto Asashima¹ (SCRC, AIST¹, Inst. for Amphibian Biology, Grad. Sch. of Sci. Hiroshima Univ.²)
- P-154A**
(SW2-03) Instructive role of Lhx1 on the formation of organizer and three germ layers in epiblasts
 エピブラストで Lhx1 はオーガナイザー、3 胚葉形成において指令的な役割を持つ。
 °Akira Hasegawa¹, Tasuku Yoshimoto¹, Nobuhito Ikeda¹, Takafumi Nakamura², Ichiro Hisatome¹, Yasuaki Shirayoshi¹ (DRMT, Tottori Univ.¹, DIB, Tottori Univ.²)
- P-155B** OTX2 and DKK1 Exhibit the Earliest Asymmetric Expression in Distal Visceral Endoderm.
 OTX2 と DKK1 は Distal Visceral Endoderm において最も早く非対称に発現する遺伝子である
 °Hideharu Hoshino¹, Go Shioi², Hiroshi Kiyonari², Takaya Abe², Kazuki Nakao², Shinichi Aizawa¹ (RIKEN CDB¹, LARGE, CDB, RIKEN²)
- P-156B**
(SW1-01) How organ size is determined in zebrafish Kupffer's vesicle?
 ゼブラフィッシュのクッペル胞形成において、器官の大きさはどのように決定されるのか？
 °Hiroshi Ishikawa¹, Sohei Yamada¹, Naoyuki Tahara¹, Tatsuro Matta¹, Eri Sumino¹, Yasumasa Bessho¹, Yoichiro Hosokawa², Takaaki Matsui¹ (Gene Regulation Research, Graduate School of Biological Sciences, NAIST¹, Green Bio Nano, Graduate School of Materials Science, NAIST²)
- P-157A** Anterior-posterior (A-P) axis formation in soft-shelled turtle and gecko
 スッポンとヤモリにおける前後軸形成
 °Eriko Kajikawa¹, Michio Yoshida¹, Daisuke Kurokawa^{1,2}, Daisuke Yamamoto¹, Miyuki Noro^{1,3}, Shige-hiro Kuraku³, Shinichi Aizawa¹ (Lab. for Vertebrate Body Plan, RIKEN CDB¹, MMBS, Univ. Tokyo², Genome Resource and Analysis Unit, RIKEN CDB³)
- P-158A** Functional analyses of *Mab21l2* during intestine development
 消化管形成過程における *Mab21l2* の機能解析
 °Chie Kobayashi, Yohei Saito, Takuya Kojima, Naoki Takahashi (Grad. Sch. Agr. Life Sci., Univ Tokyo)
- P-159B**
(FT01-02) PRL is involved in the development of mesenchymal cells in *Strongylocentrotus purpuratus*
 °Li-Yi Lin¹, Han-Ru Li², Ming-Der Lin¹, Yi-Hsien Su² (MBHG, Tzu-Chi University, Taiwan¹, ICOB, Academia Sinica, Taiwan²)
- P-160B** Functions of Polycomb group gene in regulation of Hox gene expression in a primitive mode of insect embryogenesis in the cricket *Gryllus bimaculatus*
 原始的発生様式をとる昆虫の胚発生過程におけるポリコム遺伝子群によるホメオティック遺伝子発現の制御機能
 °Yuji Matsuoka¹, Tetsuya Bando², Takahito Watanabe³, Sumihare Noji¹, Taro Mito¹ (Dept. of Bio. Sci. and Tech., Fact. of Eng., Tokushima Univ.¹, Grad. School of Med, Dent. and Pharm. Sci., Okayama Univ.², Center for Collab. among Agri., Indust. and Commerce, Tokushima Univ.³)
- P-161A** Development of circadian rhythm in the suprachiasmatic nuclei in a marine fish, flounder (*Paralichthys olivaceus*) embryos
 ヒラメ孵化仔魚における視交叉上核での概日リズムの発生
 °Makoto Mogi¹, Susumu Uji², Hayato Yokoi¹, Tohru Suzuki¹ (Grad. Sch. Agr. Sci., Tohoku Univ.¹, NRIA²)

- P-162A** The effects of rapamycin and Ex-527 on early embryogenesis in *Xenopus*
ツメガエル初期発生におけるラパマイシン及び Ex-527 の影響
Yoshihisa Ohata², Shinya Matsukawa³, Yuki Moriyama⁴, Tatsuo Michiue³, [○]Kenta Morimoto¹, Hiroki Kuroda¹ (Environment & Info. Studies, Keio Univ.¹, Graduate School of Science and Technology, Shizuoka University², Department of Life Sciences, Graduate School of Arts and Sciences, The University of Tokyo³, Howard Hughes Medical Institute and Department of Biological Chemistry, University of California, Los Angeles⁴)
- P-163B** Dynamics of Histone H2A Variants in the Mouse Somatic Cell Nuclear Transfer Embryos by the Treatment of HDAC Inhibitors
ヒストン脱アセチル化酵素阻害剤によるマウス体細胞核移植胚におけるヒストン H2A バリエーションの動態
[○]Masataka Nakaya¹, Rika Azuma¹, Masayuki Anzai², Satoshi Kishigami¹, Yoshihiko Hosoi^{1,2}, Masahiko Harata³, Tasuku Mitani² (Grad. Sch. of Biol.-Oriented Sci. Technol., Kinki Univ.¹, Inst. Adv. Technol., Kinki Univ.², Grad. Sch. of Agri. Sci., Tohoku Univ.³)
- P-164B (FT01-03)** Anterior/posterior patterning of the dorsal mesoderm in vertebrates evolved as a novelty from the ancestral chordate mesoderm by heterochronic/heterotopic shifts
脊椎動物背側中胚葉の前後軸パターン形成は祖先的脊索動物のヘテロクロニック及びヘテロトピックシフトによって進化した新規形質である。
[○]Takayuki Onai, Toshihiro Aramaki², Hidehiko Inomata³, Tamami Hirai¹, Shigeru Kuratani¹ (RIKEN CDB¹, Graduate School of Frontier Biosciences, Osaka University², Laboratory for Axial Pattern Dynamics, RIKEN Center for Developmental Biology³)
- P-165A (FT01-04)** Mechanism and significance of Wnt protein distribution in the mouse spinal cord
マウス神経管における Wnt タンパク質分布の制御と意義
[○]Takuma Shinozuka^{1,2}, Ritsuko Takada², Shinji Takada^{1,2} (Dept. Basic Biology, SOKENDAI¹, NIBB²)
- P-166A (FT01-05)** Cell surface epimorphin triggers cardiomyocyte differentiation in embryonal carcinoma P19CL6 cells
細胞膜エピモルフィンが胚性癌細胞 P19CL6 の心筋分化を引き起こす
[○]Takashi Tagawa, Natsumi Hagiwara, Yohei Hirai (Kwansei Gakuin Univ.)
- P-167B** Mammalian GyrI-like gene has an essential role in early mouse embryonic development
大腸菌トポイソメラーゼ Gyrase を阻害する GyrI タンパク質の哺乳類ホモログはマウス胚発生で必須な役割を担う
[○]Sho Takaoka^{1,2}, Masayuki Yokoi², Akira Nakanishi³, Masamichi Yamamoto⁴, Fumio Hanaoka^{1,2} (Grad. Sch. Front. Biosci., Osaka Univ.¹, Fac. Sci., Gakushuin Univ.², Dep. Mol. Genetics, Med. Res. Inst., Tokyo Medical & Dental Univ.³, Advanced Scientific Research Leaders Development Unit, Gunma Univ.⁴)
- P-168B** Establishment of vertebrate body plan via coordinated regulation of dorsal-ventral and anterior-posterior patterning during early *Xenopus* embryogenesis
胚発生初期に背腹と頭尾のパターン形成を統合する分子機構
[○]Kimiko Takebayashi-Suzuki, Hidenori Konishi, Atsushi Suzuki (Inst. for Amphibian Biol., Hiroshima Univ. Grad. Sch. of Sci.)
- P-169A (FT01-06)** The establishment of the Left-right asymmetry in sea urchin embryo
ウニ胚における左右非対称性決定機構
[○]Ayumi Takemoto¹, Fumie Shimono^{2,3}, Tatsuo Miyamoto⁴, Akinori Awazu¹, Hiraku Nishimori¹, Takashi Yamamoto¹, Naoaki Sakamoto¹ (Dept. of Math. and Life Sci., Hiroshima Univ.¹, Hiroshima Kokudaiji High Sch.², Edu. Proj. for Excit. Sci. Hiroshima Univ.³, Dept. of Genet. and Cell Biol., Res. Inst. for Radiation Biol. and Med., Hiroshima Univ.⁴)

- P-170A** Analysis of expression patterns of Cdx2 and cell movement in mouse preimplantation embryos by live-cell imaging
ライブイメージングによるマウス着床前胚における Cdx2 遺伝子の発現局在の観察
○Yayoi Toyooka, Sanae Oka, Toshihiko Fujimori (NIBB)
- P-171B (FT01-07)** Targeted mutagenesis of *Xenopus laevis* gene by CRISPR/Cas system
CRISPR/Cas システムによるアフリカツメガエル遺伝子への変異の導入
Mari Yamada, ○Minoru Watanabe (Fac.of Integrated Arts & Scis., The Univ. of Tokushima.)
- P-172B (FT01-08)** Ezrin mediates the function of Inpp5e in ciliogenesis and polycystic kidney disease
○Wenyan Xu, Miaomiao Jin, Fan Zhang, Hong Wang, Ying Cao (SLST, Tongji Univ.)
- P-173A (SW1-06)** A brand-new model of amphibian gastrulation
両生類における新しい原腸形成モデル
○Takanori Yanagi^{1,2}, Chikara Hashimoto^{1,2} (Dept. of Biol. Sci., Sch. of Sci, Osaka Univ.¹, JT Biohistory Research Hall²)
- P-174A** Comparative gene expression analysis in anterior-posterior axis formation of non-rodent mammals
非齧歯類哺乳動物の前後軸形成における遺伝子発現の比較解析
○Michio Yoshida¹, Eriko Kajikawa¹, Daisuke Yamamoto¹, Daisuke Kurokawa², Akira Onishi³, Tomoyuki Tokunaga⁴, Shinichi Aizawa¹ (Body plan, CDB, RIKEN¹, MMBS, Tokyo Univ.², NIAS³, NIAS⁴)
- P-175B** Analysis of the function of R31 limb specific enhancer of *Fgf10*.
Fgf10 肢芽特異的エンハンサー R31 の機能解析
○Chisa Ando, Yu-hei Kohara, Yo-ichi Yamamoto-Shiraishi, Atsushi Kuroiwa (Div. of Biol. Sci., Grad. Sch. of Sci., Nagoya Univ)
- P-176B (FT02-01)** Nano scale morphogenesis of porous extracellular matrix in *Drosophila* olfactory sensilla
ショウジョウバエ嗅覚毛における多孔性細胞外マトリックスのナノスケールでの形態形成
○Toshiya Ando¹, Kazuyo Misaki², Shigenobu Yonemura², Shigeo Hayashi¹ (RIKEN CDB, Laboratory for Morphogenetic Signaling¹, RIKEN CDB, Electron Microscope Laboratory²)
- P-177A** Fat body-derived apical extracellular matrix enzyme is transported to the airway lumen and regulates tube morphogenesis
○Bo Dong, Shigeo Hayashi (RIKEN CDB)
- P-178A (FT02-02)** Comparative analyses of RTFL peptide family on control of plant organogenesis
○Pin Guo¹, Asami Yoshimura², Naoko Ishikawa³, Takahiro Yamaguchi⁴, Keiko Sakakibara², Takayuki Kohchi⁵, Youhao Guo¹, Hirokazu Tsukaya² (Wuhan University¹, Department of Biological Sciences, Graduate School of Science, University of Tokyo², Saitama Museum of Natural History³, Acel, Inc.⁴, Graduate School of Biostudies, Kyoto University⁵)
- P-179B (FT02-03)** A Mathematical Model of Polygonal Cells for a Three-dimensionally Undulated Cell-sheet
3次元空間で変形自由自在の細胞シートをつくる細胞形態形成モデル
○Hisao Honda^{1,2} (Medicine, Kobe Univ.¹, RIKEN CDB²)
- P-180B** α cells regulate pancreatic progenitor cell expansion and endocrine cell number through Wnt4 expression during early pancreas development
 α 細胞は、Wnt4 の発現を介して、膵臓前駆細胞の増殖と内分泌細胞の数を制御している
○Keiichi Katsumoto¹, Jingdong Shan², Carsten Gustavsen¹, Palle Serup¹, Seppo Vainio², Anne Grapin-

Botton¹ (Danstem, University of Copenhagen¹, Department of Medical Biochemistry and Molecular Biology, University of Oulu²)

P-181A
(FT02-04)

The Quail Polydactyly Mutant, HMM, shows Inactivation of SHH Signaling

多指症を発症する HMM ウズラ変異体では SHH シグナルが不活性化している

○Kazuki Kawamura¹, Yoshiyuki Matsubara¹, Mikiharu Nakano², Masaoki Tsudzuki³, Yoichi Matsuda^{2,4}, Atsushi Kuroiwa¹, Takayuki Suzuki¹ (Grad School of Sci, Nagoya Univ¹, ABRC, Grad School of Bioag Sci, Nagoya Univ², Grad School of Biosphere Sci, Hiroshima Univ³, Grad School of Bioag Sci, Nagoya Univ⁴)

P-182A
(FT02-05)

Toward understanding the mechanisms that restricts where spicules are held up during spiculous skeleton construction of sponges

カイメンの骨片が立てられる位置を決める機構の解明に向けて

○Kouji Kishimoto, Chihiro Inui, Kiyokazu Agata, Noriko Funayama (Dept. of Biophysics, Graduate School of Science, Kyoto Univ.)

P-183B

Chirality in cell plane is associated with collective migration of epithelial cells

回転する器官形成を支える上皮細胞集団移動のしくみ

Ayako Isomura, Emi Maekawa, Aimi Tsukioka, ○Erina Kuranaga (Lab Histogenetic Dyn, RIKEN CDB)

P-184B

Early Zebrafish Development, a Screening Model to Identify Effects of Endocrine Disrupting Chemicals

○Kp Lai¹, Bhy Yeung², Ht Wan², Wkf Tse², Ckc Wong² (HKU¹, BIOL, HKBU²)

P-185A
(FT02-06)

Characterization of *polr1c* in facial development related to the Treacher Collins Syndrome

○Marco CC Lau, William KF Tse (BIOL, HKBU)

P-186A
(FT02-07)

Heterochrony in initiation of paraxial *Gdf11* expression specifies unique hindlimb positioning in tetrapods

Gdf11 発現開始タイミングのヘテロクロニーが四肢動物の後肢の位置の多様性を生み出す

○Yoshiyuki Matsubara¹, Ayumi Hattori², Yusuke Watanabe², Atsushi Sakai³, Guojun Sheng⁴, Toshihiko Ogura², Atsushi Kuroiwa¹, Takayuki Suzuki^{1,5} (Div of Biol Sci, Grad Sch of Sci, Nagoya Univ.¹, IDAC, Tohoku Univ.², The Japan Snake Institute³, RIKEN CDB⁴, JST PRESTO⁵)

P-187B

In vivo study of *Msx1* gene in mice using CRISPR/Cas system

○Silvia Mitsui¹, Akihiro Yasue¹, Issei Imoto², Seiichi Oyadomari³, Sumihare Noji⁴, Taro Mito⁴, Eiji Tanaka¹ (Department of Orthodontics and Dentofacial Orthopedics, Institute of Health Biosciences, The Univ. of Tokushima Graduate School¹, Department of Human Genetics and Public Health, Institute of Health Biosciences, The University of Tokushima Graduate School², Division of Molecular Biology, Institute for Genome Research, The University of Tokushima³, Department of Life Systems, Institute of Technology and Science, The University of Tokushima⁴)

P-188B
(FT02-08)

Role of anteroposterior tissue polarity in elongation movement of *Xenopus* posterior neural tissue

ツメガエル後方神経組織の伸長運動における組織極性の働き

○Hiromasa Ninomiya (AIST)

P-189A

Overview of twinning formation in *Xenopus laevis* embryo

アフリカツメガエル 2 次胚の生じ方

○Eiji Sato¹, Yasuko Onuma², Tadayoshi Uezato¹, Naoyuki Miura¹, Yuzuru Ito² (Dept.of Biochem., Hamamatsu Univ.Sch.of Med.¹, AIST²)

P-190A

Genetic evidence that Hox embedded microRNAs are required for axial body patterning in mouse

○Tempei Sato^{1,2,3}, Moe Tamano¹, Masafumi Inui¹, Shuji Takada¹, Hiroshi Asahara^{1,2,4} (Dept. of Syst. BioMed., Natl. Res. Inst. for Child Health and Dev.¹, Dept. of Syst. BioMed., Tokyo Med. and Dent. Univ.², JSPS Research Fellow³, CREST, JST⁴)

P-191B

Homeotic transformation of the upper jaw into lower jaw-like structures in Dlx5-overexpressing mice.

Dlx5 過剰発現マウスにおける上顎の下顎構造へのトランスフォーメーション

○Miki Shimizu¹, Taro Kitazawa¹, Yumiko Kawamura¹, Nicolas Narboux-Nme², Giovanni Levi², Yasunobu Uchijima¹, Yukiko Kurihara¹, Hiroki Kurihara¹ (Dept. Physiol. Chem. & Metab., Grad. Sc. of Med., Univ. of Tokyo¹, UMR7221 CNRS-MNHN²)

**P-192B
(FT02-09)**

Latrophilin-2 is involved in the migration and differentiation of neural crest cells.

Latrophilin-2 は神経堤細胞の遊走、分化に関与する。

○Kosuke Tanegashima¹, Marianna Suzuki^{1,2}, Kenji Suzuki¹, Tatsuo Michiue³, Takahiko Hara¹ (Stem Cell Project, Tokyo Metropol. Inst. Med. Sci.¹, Grad. Sch. of Tokyo Med. Dent. Univ.², Dep. of Life Sci., Grad. Sch. of Arts and Sci., Univ. of Tokyo³)

P-193A

Role of *Mab21l2* in Palatogenesis

○Wai Hung Tsang, Fei Sun, King Lau Chow (LIFS, HKUST)

**P194A
(FT02-10)**

Loss-of-function analysis of deubiquitylating enzymes reveals their importance in zebrafish craniofacial development

○William Ka Fai Tse (BIOL, HKBU)

**P-195B
(FT02-12)**

The role of zebrafish *cdx1b* in left-right patterning

○Chun-Shiu Wu, Sheng-Ping L. Hwang, Chang-Jen Huang (IBC, NTU)

P-196B

LGR4 is required for the development of sequential molars.

新規膜受容体 LGR4 はマウス臼歯の連続的発生を制御する

○Yukiko Yamakami, Kazunori Oyama, Yasuaki Mohri, Katsuhiko Nishimori (Lab. of Mol. Biol., Grad. Sch. of Agri. Sci., Tohoku Univ.)

**P-197A
(FT02-13)**

Discontinuous Transitions of Phyllotaxis: The Cases of *Thuja occidentalis* (Cupressaceae) and *Diphasiastrum digitatum* (Lycopodiaceae)

○Xiaofeng Yin^{1,2,4}, Christian Lacroix², Denis Barabe³, Roger Meicenheimer⁴ (Dept. Bio. Sci., Gra. Sch. Sci., Univ. Tokyo¹, Department of Biology, University of Prince Edward Island. Canada², Plant Biology Research Institute, Montreal Botanical Garden. Canada³, Department of Botany, Miami University. USA⁴)

**P-198A
(FT02-14)**

Identification of ocular- or blind-side enriched genes in flounder metamorphosis

ヒラメ変態過程において有眼側および無眼側で発現する遺伝子の解析

○Hayato Yokoi, Xiaoming Wu, Yoshifumi Sakai, Tohru Suzuki (Grad Sch Agricul Sci, Tohoku Univ)

Technical Workshop: Fundamentals of Quantitative Image Analysis

May 27 (Tue) 13:00 ~ 16:00 Room A
Chairpersons: Hiroshi Koyama (NIBB)
Kagayaki Kato (NINS/CNSI)

Image processing has been recognized as an indispensable tool in the field of developmental biology, largely due to the evolution of microscopies. The basic concepts and techniques, however, do not seem to be shared among developmental biologists. Moreover, interpretations of image processing/analysis results have yet to be discussed. This workshop will provide a basic lecture and a short practice for image processing/analysis, and a few advanced lectures. We recommend you to attend the practice with your laptop in which the ImageJ software and sample images (available at our web site; <http://is.cnsi.jp/> ...) are installed in advance. The advanced lectures will not only provide practical cases of image processing/analysis but also cover subsequent statistical analyses and statistical/mathematical modellings. Supported by Grant-in-Aid for Scientific Research on Innovative Areas “Cross-talk between moving cells and microenvironment as a basis of emerging order in multicellular system”

13:00-13:10 Introduction

TW01-1 13:10-14:10 Quantitative image processing: lecture and practice
定量的画像処理：講義と演習
○Yoshitaka Kimori (CNSI/NINS)

14:10-14:20 Short break

TW01-2 14:20-14:40 Quantitative image analysis of collective cell migration
細胞集団移動様式の定量的画像解析
○Kagayaki Kato (NINS/CNSI)

TW01-3 14:40-15:10 Image analysis for plant cell biology
画像解析と植物細胞の生物学
○Natsumaro Kutsuna (GSFS, Univ. Tokyo)

TW01-4 15:10-15:40 Analysis of Multicellular Dynamics with Image Processing
画像解析による多細胞動態の解析
○Kazuhiro Aoki (Grad. Sch. Med., Kyoto Univ.)

15:40-16:00 Discussion

Satellite Workshops (in Japanese)

SW01: Morphogenesis and Signaling

May 27 (Tue) 13:00 ~ 16:00 Room B

Chairpersons: Shunya Hozumi (Hiroshima Univ.)

Yo-ichi Yamamoto-Shiraishi (Nagoya Univ.)

Katsuyoshi Takaoka (Osaka Univ.)

Takamasa Mizoguchi (Chiba Univ.)

- SW1-01 (P156B)** 13:00-13:15 How organ size is determined in zebrafish Kupffer's vesicle?
ゼブラフィッシュのクッペル胞形成において、器官の大きさはどのように決定されるのか?
○Hiroshi Ishikawa¹, Sohei Yamada¹, Naoyuki Tahara¹, Tatsuro Matta¹, Eri Sumino¹, Yasumasa Bessho¹, Yoichiro Hosokawa², Takaaki Matsui¹ (Gene Regulation Research, Graduate School of Biological Sciences, NAIST¹, Green Bio Nano, Graduate School of Materials Science, NAIST²)
- SW1-02 (P134A)** 13:15-13:30 Apolipoprotein A-I is involvement in the liver regionalization via control BMP signaling.
Apolipoprotein A-I は BMP シグナルの調節を介して肝臓の領域化に働く。
○Satoru Shimura, Hiroyuki Kawahara, Kimiko Fukuda (Dept. Biol. Sci., Tokyo Metr. Univ.)
- SW1-03 (P107B)** 13:30-13:45 Cadherin-7 joins dorsal-ventral patterning of the chick embryonic spinal cord through sonic hedgehog signaling
カドヘリン-7 はソニックヘッジホッグシグナルを介し、ニワトリ胚神経管の背腹軸に沿った形態形成に関与している
○Rie Kawano, Kunimasa Ohta, Naofumi Ito (Dev. Neurobio. Kumamoto University)
- SW1-04 (P039B)** 13:45-14:00 Analysis of the mechanism to enrich a chromodomain protein MRG-1 into the primordial germ cells in *C.elegans*
線虫 *C.elegans* における、クロモドメインタンパク MRG-1 の始原生殖細胞への限局メカニズムの解析
○Takashi Miwa, Kunio Inoue, Hiroshi Sakamoto, Teruaki Takasaki (Kobe Univ.)
- SW1-05 (P049A)** 14:00-14:15 Reaction-diffusion pattern in shoot apical meristem of plants
植物茎頂分裂組織における反応拡散パターン
○Hironori Fujita¹, Masayoshi Kawaguchi^{1,2} (Natl. Inst. Basic Biol.¹, Grad. Univ. Adv. Stud.²)
- SW1-06 (P173A)** 14:15-14:30 A brand-new model of amphibian gastrulation
両生類における新しい原腸形成モデル
○Takanori Yanagi^{1,2}, Chikara Hashimoto^{1,2} (Dept. of Biol. Sci., Sch. of Sci, Osaka Univ.¹, JT Biohistory Research Hall²)
- SW1-07 (P031B)** 14:30-14:45 Replication-coupled passive DNA demethylation for the erasure of genome imprints in mice
ゲノムインプリント消去における受動的脱メチル化の寄与
○Saya Kagiwada^{1,2}, Kazuki Kurimoto^{1,2}, Fumiyoshi Ishidate³, Mitinori Saitou^{1,2,4,5} (Kyoto Univ.¹, ERATO, Kyoto², CeMI, Kyoto Univ.³, CiRA, Kyoto Univ.⁴, iCeMS, Kyoto Univ.⁵)

- SW1-08 (P121A)** 14:45-15:00 Unexpected role of blood platelets in lung development depending on a novel platelet activation receptor, CLEC-2
血小板が正常な肺発生を可能にする - 新規血小板活性化受容体 CLEC-2 の機能解析 -
○Nagaharu Tsukiji¹, Osamu Inoue², Shogo Tamura¹, Toshiaki Shirai¹, Katsue Inoue¹, Yukio Ozaki¹ (Department of Clinical and Laboratory Medicine, Faculty of Medicine, University of Yamanashi¹, Infection Control Office, University of Yamanashi Hospital, Faculty of Medicine, University of Yamanashi²)
- SW1-09 (P118A)** 15:00-15:15 Celf1 Regulates Endoderm Proliferation and Migration In Zebrafish
ゼブラフィッシュ胚における RNA 結合タンパク celf1 の内胚葉由来の器官形成に対する制御機構の解明
○Naoyuki Tahara, Bessho Yasumasa, Takaaki Mtatsui (NAIST)
- SW1-10 (P133A)** 15:15-15:30 Analysis of the Delta signaling as the reverse signaling of Notch during mouse development
マウス胚発生における Notch とは逆方向の Delta シグナル解析
○Yusuke Okubo¹, Katsuhide Igarashi¹, Yumiko Saga², Jun Kanno¹ (Div. of Cell. and Mol. Toxicol., NIHS¹, Div. of Mam. Dev., NIG²)

SW02: Stem Cells and Neural Development

May 27 (Tue) 13:00 ~ 16:00 Room C

Chairpersons: Tomoyasu Shinoda (Nagoya Univ.)

Yayoi Toyooka (NIBB)

Hitoshi Yokoyama (Tohoku Univ.)

Kenshiro Hara (NIBB)

- SW2-01 (P068B)** 13:00-13:15 Strain-dependent embryonic lethality induced by flanking genes in homozygous *ST8sia2*-deficient mice
ST8sia2 ノックアウトマウスにおける系統特異的フランキング遺伝子領域の胚性致死に及ぼす影響
○Keisuke Ikegami¹, Kazumasa Saigoh², Mamoru Nagano¹, Susumu Kusunoki², Yasufumi Shigeyoshi¹ (Dept. Anato. Neurobiol., Kinki Univ. Facul. Med.¹, Dept. Neurology., Kinki Univ. Facul. Med.²)
- SW2-02 (P018A)** 13:15-13:30 PRDM14 promotes naïve pluripotency through TET-BER-mediated active demethylation
PRDM14 による TET-BER 経路を介した多能性獲得機構の解明
○Jun Nakamura, Naoki Okashita, Yoshiyuki Seki (K.G. Univ.)
- SW2-03 (P154A)** 13:30-13:45 Instructive role of Lhx1 on the formation of organizer and three germ layers in epiblasts
エピブラストで Lhx1 はオーガナイザー、3 胚葉形成において指令的な役割を持つ。
○Akira Hasegawa¹, Tasuku Yoshimoto¹, Nobuhito Ikeda¹, Takafumi Nakamura², Ichiro Hisatome¹, Yasuaki Shirayoshi¹ (DRMT, Tottori Univ.¹, DIB, Tottori Univ.²)
- SW2-04 (P050A)** 13:45-14:00 CARL: a newly developed transcriptome assembler for non-model organisms
CARL: 非モデル生物用新型 de novo トランスクリプトームアセンブラー
○Makoto Kashima, Suguru Kato, Eri Kawaguchi, Hayoung Lee, Kiyokazu Agata, Norito Shibata (DBGS, Kyoto Univ.)

- SW2-05 (P087B)** 14:00-14:15 Semaphorin/plexin signaling regulates the development of the amygdala-BNST network
セマフォリン/プレキシシン シグナルは扁桃体と分界条床核との接続を制御する
○Fumikazu Suto¹, Masahumi Kawaguchi¹, Noriko Osumi², Noritaka Ichinohe¹ (NINS, NCNP¹, Div. Dev. Neurosci., Tohoku Univ. Grad. Sch. of Med.²)
- SW2-06 (P001A)** 14:15-14:30 A classical niche for spermatogonial stem cells in the proximal tip of the seminiferous tubules in mammalian testes
曲精細管の末端部における古典的な精子幹細胞ニッチの発見
○Yoshimi Aiyama, Yoshiakira Kanai (Dept. of Vet. Anat, The Univ. of Tokyo)
- SW2-07 (P094A)** 14:30-14:45 Conserved roles of PRDM14 orthologues in DNA demethylation and pluripotency in embryonic stem cells
種間比較を用いた PRDM14 の機能解析
○Shota Hashimoto, Akari Shirakami, Yoshiyuki Seki (K.G. Univ)
- SW2-08 (P088B)** 14:45-15:00 Establishment of neural circuit by interaction between cells of different origins
由来の異なる細胞同士の相互作用による神経回路の形成機構
○Takumi Suzuki¹, Masako Kaido¹, Rie Takayama¹, Makoto Sato^{1,2} (Brain/Liver Center, Kanazawa Univ¹, PRESTO, JST²)
- SW2-09 (P022A)** 15:00-15:15 Transgenic imaging and tracing of the wound epidermis during zebrafish fin regeneration
ゼブラフィッシュ再生傷上皮のトランスジェニックイメージングと細胞系譜解析
○Eri Shibata¹, Kazunori Ando¹, Natsumi Horita¹, Gembu Abe², Koichi Kawakami², Akira Kudo¹, Atsushi Kawakami¹ (Tokyo tech¹, NIG²)
- SW2-10 (P084B)** 15:15-15:30 Axonal mRNAs encoding transcription factors in the tectum of chick embryos
ニワトリ胚中脳視蓋でみられる転写因子をコードする軸索性 mRNA
○Nozomi Onodera^{1,2}, Hiroshi Nakata², Miwa Watanabe³, Yasuhiro Itoh⁴, Isato Araki^{1,2} (UGAS, Iwate Univ¹, Dept Chem Bioeng, Fac Eng, Iwate Univ², Tech Div, Fac Eng, Iwate Univ³, Grad Sch Pharm Sci, Univ Tokyo⁴)
- SW2-11 (P028B)** 15:30-15:45 Distal blastema is a signaling center that directs cell proliferation during zebrafish fin regeneration
ヒレ再生で先端再生芽は細胞増殖を指令する細胞集団である
○Yuki Yokota¹, Natsumi Horita¹, Gembu Abe², Koichi Kawakami², Akira Kudo¹, Atsushi Kawakami¹ (Dept. Biol. Info., Tokyo Inst. Tech¹, National Institute of Genetics²)

日本発生生物学会第47回大会 市民公開講座

発生学ゆりかごから墓場まで—進化・幹細胞・老化



2014年5月31日(土) 13:00~16:00

参加費無料

場 所:名古屋大学 野依記念学術交流館 (〒464-8602 名古屋市千種区不老町)

世話人:日比 正彦(名古屋大学生物機能開発利用研究センター)

共 催:名古屋大学生物機能開発利用研究センター

第1部 講演 (13:00~15:15)

- ① なぜ?どうして?がんにならない
超長寿ハダカデバネズミ
三浦 恭子(北海道大学 遺伝子病制御研究所)
- ② 万能細胞について
升井 伸治(京都大学iPS細胞研究所)
- ③ カブトムシの角作りの秘密を探る
新美 輝幸(名古屋大学 大学院生命農学研究科)

第2部 パネルディスカッション (15:20~16:00) 『どこに向かうの生物学?』

パネラー: 三浦 恭子、升井 伸治、新美 輝幸、矢追 雄一(県立岐阜高校)
司 会: 日比 正彦(名古屋大学生物機能開発利用研究センター)

<http://www.jsdb.jp/kaisai/jsdb2014/>



講演要旨

1 なぜ? どうして? がんにならない 超長寿ハダカデバネズミ

三浦 恭子 (北海道大学 遺伝子病制御研究所)

ハダカデバネズミは、その名の通りネズミの仲間ですが、30年近くも生き、また、がんにならない、老化しない、とても不思議なネズミです。さらに、哺乳類では珍しい、アリやハチのようなカースト社会(女王、王、ワーカー)で暮らしています。この不思議な生態や、不思議なからだの仕組み、そしてその謎に迫る研究をご紹介します。

2 万能細胞について

升井 伸治 (京都大学IPS細胞研究所)

私たちの身体を作っている細胞は、それぞれが特定の役割を果たしています。最近まで、役割が一旦決まった後の細胞は、決まる前の万能細胞には戻らないと考えられていました。ところがiPS細胞の発見以来、この見方は大きく変わってきました。この講演では、万能性をとりもどすしくみについて、iPS細胞を例に、どこまでわかっているのかをわかりやすく解説します。

3 カブトムシの角作りの秘密を探る

新美 輝幸 (名古屋大学 大学院生命農学研究所)

カブトムシの人気の秘密は、雄だけに存在する格好いい大きな角にあります。このように雄だけがもつ立派な角は、雌を獲得するための雄同士の闘争用の武器として進化してきたと考えられています。雄で過剰に発達した角は、ダーウィンの著書「人間の由来と性淘汰」にも記され、古くから多くの研究者の興味を集めてきました。ところが、角がどのような遺伝子によって作られているのかはほとんど解明されていません。本講演では、カブトムシの角作りの秘密を解き明かすためにこれまで行ってきた性差をもたらす遺伝子の解析など最新の研究成果を紹介します。

会場へのアクセス



地下鉄東山線の場合 「本山」 駅下車、名城線乗り換え
「名古屋大学」 駅下車2番出口より徒歩5分

地下鉄鶴舞線の場合 「八事」 駅下車、名城線乗り換え
「名古屋大学」 駅下車2番出口より徒歩5分

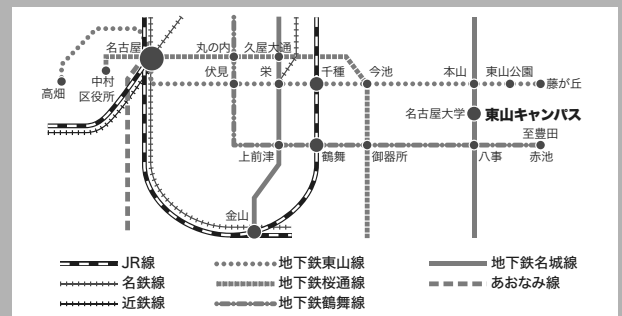

第 8 回男女共同参画ランチオンワークショップ

47th Annual meeting for the JSDB with the APDBN, 8th Gender equality workshop

日時： 5 月 30 日（金） 12:00-13:00

会場： ウィンクあいち 5 階 小ホール（Room B）

テーマ：

「男女共同参画について根本から考える」

—理想と現実—

みなさんは男女共同参画活動についてどのような印象をお持ちですか？ ライフワークバランスへの配慮、子育て支援、といった男女共同参画の啓蒙活動は重要なことだと理解されます。一方で、生命科学分野のポジションは男女問わず十分ではないにもかかわらず、男女共同参画の為にインセンティブ付与が原因で、数値目標の設置による人事バイアスや、男女逆差別の公募に対する不満が生じているのも事実です。こういった不満は跳ね返ってきて、現場で働く女性研究者の弊害ともなり得ます。このような負の連鎖を打ち破るためには、「男女共同参画」について現状に即して根本から見直し、現実に即した環境の整備とサポートの充実を具体化する必要があります。若手や女性の登用に躊躇するようなタイムリーな問題が勃発したこのタイミングだからこそ、聖域のない「ぶっちゃけ討論」を交わすことで現状を把握し、今、何が問題で、何を必要としているのか、何が出来るのか、議論したいと思っています。

ワークショップの進行にあたっては、2012 年 11 月に実施された「第 3 回大規模アンケート：科学技術系専門職の男女共同参画実態調査」の回答分析データとコメントをベースに、発生生物学会会員の生の声を例に挙げながら、パネルディスカッション形式で進めて行く予定です。もし討論したいテーマがあれば受け付けますので、事前に事務局 (jsdbadmin@jsdb.jp)までご連絡ください。参加者の皆さんからも、積極的な議論参加をお願い致します。

ランチ付き、日本語ですので、多くの方々のご参加をお待ちしております。

パネリスト（予定）：
阿形 清和（京都大学）
林 茂生（理研 CDB）
入江 直樹（東京大学）
今井-佐藤 薫（京都大学）
その他

司会進行： 吉田 薫（桐蔭横浜大学）・倉永 英里奈（理研 CDB）

主催：日本発生生物学会男女共同参画 WG
後援：男女共同参画学協会連絡会

Author Index (Speaker indicated in Bold.)

<p>A</p> <p>Abad, Maria S01-03</p> <p>Abe, Gembu OP01-07</p> <p style="padding-left: 2em;">" SW2-09 (P022A)</p> <p style="padding-left: 2em;">" SW2-11 (P028B)</p> <p>Abe, Takaya OP01-01</p> <p style="padding-left: 2em;">" P-155B</p> <p>Adachi, Mai OP07-01</p> <p style="padding-left: 2em;">" FT06-16 (P103B)</p> <p>Adachi, Tomoko OP02-10</p> <p style="padding-left: 2em;">" FT01-01 (P150A)</p> <p>Agata, Kiyokazu OP01-05</p> <p style="padding-left: 2em;">" OP02-03</p> <p style="padding-left: 2em;">" OP02-06</p> <p style="padding-left: 2em;">" OP02-12</p> <p style="padding-left: 2em;">" OP05-13</p> <p style="padding-left: 2em;">" FT02-05 (P182A)</p> <p style="padding-left: 2em;">" FT05-04 (P021A)</p> <p style="padding-left: 2em;">" FT05-05 (P019B)</p> <p style="padding-left: 2em;">" FT05-06 (P014A)</p> <p style="padding-left: 2em;">" FT05-07 (P013A)</p> <p style="padding-left: 2em;">" FT05-08 (P012B)</p> <p style="padding-left: 2em;">" FT05-13 (P007B)</p> <p style="padding-left: 2em;">" SW2-04 (P050A)</p> <p style="padding-left: 2em;">" WS1-09</p> <p style="padding-left: 2em;">" P-006A</p> <p style="padding-left: 2em;">" P-026A</p> <p>Aigouy, Benoit OP05-04</p> <p>Aikawa, Takumi WS1-05</p> <p>Aiyama, Yoshimi</p> <p style="padding-left: 2em;">SW2-06 (P001A)</p> <p>Aizawa, Shinichi P-032B</p> <p style="padding-left: 2em;">" P-155B</p> <p style="padding-left: 2em;">" P-157A</p> <p style="padding-left: 2em;">" P-174A</p> <p>Ajima, Rieko WS1-02</p> <p>Akita, Kae P-054A</p> <p>Akiyama, Masakazu</p> <p style="padding-left: 2em;">FT06-15 (P104B)</p> <p>Akiyama, Ryutaro</p> <p style="padding-left: 2em;">OP07-05</p> <p>Akiyama, Toyoko</p> <p style="padding-left: 2em;">FT01-01 (P150A)</p>	<p>Akiyama-Oda, Yasuko</p> <p style="padding-left: 2em;">OP04-11</p> <p style="padding-left: 2em;">" FT04-06 (P125A)</p> <p>Akiyoshi, Ryutaro P-036B</p> <p>Alicee, Maryam OP05-04</p> <p>Amano, Takanori</p> <p style="padding-left: 2em;">OP06-02</p> <p style="padding-left: 2em;">" FT06-03 (P041A)</p> <p style="padding-left: 2em;">" FT06-09 (P116B)</p> <p>Anai, Satoshi OP04-05</p> <p>Ando, Ayaka</p> <p style="padding-left: 2em;">FT03-03 (P065A)</p> <p>Ando, Chisa P-175B</p> <p>Ando, Joji S05-02</p> <p>Ando, Kazunori</p> <p style="padding-left: 2em;">SW2-09 (P022A)</p> <p>Ando, Sayuri OP02-08</p> <p>Ando, Toshiya</p> <p style="padding-left: 2em;">FT02-01 (P176B)</p> <p>Ando, Yuki OP06-06</p> <p>Anzai, Masayuki P-163B</p> <p>Aoki, Hitomi</p> <p style="padding-left: 2em;">FT03-09 (P075B)</p> <p>Aoki, Kazuhiro TW01-4</p> <p>Ao-Kondo, Hiroko P-064B</p> <p>Aoyama, Tsuyoshi</p> <p style="padding-left: 2em;">OP02-08</p> <p>Araki, Isato</p> <p style="padding-left: 2em;">FT03-14 (P082A)</p> <p style="padding-left: 2em;">" SW2-10 (P084B)</p> <p>Araki, Takashi S06-05</p> <p>Arendt, Thomas OP01-06</p> <p>Ariizumi, Takashi</p> <p style="padding-left: 2em;">FT05-02 (P029A)</p> <p>Arishige, Masahiko</p> <p style="padding-left: 2em;">P-110A</p> <p>Asahara, Hiroshi P-190A</p> <p>Asakawa, Kazuhide</p> <p style="padding-left: 2em;">OP01-07</p> <p style="padding-left: 2em;">" FT03-12 (P079B)</p> <p style="padding-left: 2em;">" FT06-07 (P090A)</p> <p>Asashima, Makoto</p> <p style="padding-left: 2em;">OP07-09</p>	<p style="padding-left: 2em;">" P-153A</p> <p>Ashida, Yuhei P-151B</p> <p>Aszodi, A.</p> <p style="padding-left: 2em;">FT03-01 (P061A)</p> <p>Atsumi, Yu OP03-01</p> <p>Atsuta, Yuji S01-04</p> <p>Au, T. FT03-01 (P061A)</p> <p>Averbukh, Inna S07-01</p> <p>Awasaki, Takeshi P-062A</p> <p>Awazu, Akinori</p> <p style="padding-left: 2em;">FT01-06 (P169A)</p> <p>Ayukawa, Tomonori</p> <p style="padding-left: 2em;">FT06-15 (P104B)</p> <p>Azuma, Rika P-163B</p> <p style="text-align: center;">B</p> <p>Baba, Tadashi P-102A</p> <p>Bando, Masashige</p> <p style="padding-left: 2em;">OP05-03</p> <p>Bando, Tetsuya P-003B</p> <p style="padding-left: 2em;">" P-160B</p> <p>Barabe, Denis</p> <p style="padding-left: 2em;">FT02-13 (P197A)</p> <p>Barbu, Corina OP01-06</p> <p>Barkai, Naama S07-01</p> <p>Barry, Merriman OP07-12</p> <p>Bashar, Khayrul S03-06</p> <p>Ben, Jin S04-01</p> <p>Bessho, Yasumasa</p> <p style="padding-left: 2em;">OP07-05</p> <p style="padding-left: 2em;">" SW1-01 (P156B)</p> <p style="padding-left: 2em;">" SW1-09 (P118A)</p> <p>Bischoff, Marcus S01-05</p> <p>Briscoe, James S07-02</p> <p>Bruno, Reversade OP07-12</p> <p>Bullmann, Torsten</p> <p style="padding-left: 2em;">OP01-06</p> <p style="text-align: center;">C</p> <p>Campo, Cristina Villa del</p> <p style="padding-left: 2em;">S01-07</p> <p>Canamero, Marta S01-03</p> <p>Cao, Ying</p> <p style="padding-left: 2em;">FT01-08 (P172B)</p> <p>Chan, Chung Man</p>	<p style="padding-left: 2em;">FT03-02 (P063B)</p> <p style="padding-left: 2em;">" P-063B</p> <p>Chan, D.</p> <p style="padding-left: 2em;">FT03-01 (P061A)</p> <p>Chan, Danny S04-06</p> <p style="padding-left: 2em;">" P-140B</p> <p>Chan, Tzu-Min</p> <p style="padding-left: 2em;">FT03-10 (P076B)</p> <p>Chan, Wilson P-140B</p> <p>Chang, Chun-Che</p> <p style="padding-left: 2em;">FT04-12 (P101A)</p> <p>Chatani, Masahiro</p> <p style="padding-left: 2em;">OP02-02</p> <p>Cheah, K. S.E.</p> <p style="padding-left: 2em;">FT03-01 (P061A)</p> <p>Cheah, Kathryn P-140B</p> <p>Cheah, Kathryn SE</p> <p style="padding-left: 2em;">S04-06</p> <p>Chen, Chun-Yu P-152B</p> <p>Chen, Yu-Chia</p> <p style="padding-left: 2em;">FT03-10 (P076B)</p> <p>Chen, Yujun OP03-10</p> <p>Chien, Chung-Liang</p> <p style="padding-left: 2em;">FT03-05 (P067B)</p> <p style="padding-left: 2em;">" FT04-08 (P056B)</p> <p>Chow, King Lau</p> <p style="padding-left: 2em;">FT03-02 (P063B)</p> <p style="padding-left: 2em;">" P-063B</p> <p style="padding-left: 2em;">" P-193A</p> <p>Chow, Wei-Yuan</p> <p style="padding-left: 2em;">FT03-10 (P076B)</p> <p>Ciruna, Brian WS2-10</p> <p>Claveria, Cristina S01-07</p> <p>Clevers, Hans PL-02</p> <p>Collins, Jim S08-04</p> <p style="text-align: center;">D</p> <p>Dahmann, Christian</p> <p style="padding-left: 2em;">OP05-04</p> <p>Date, Shoichi S02-04</p> <p>Degani, Neta S07-01</p> <p>Deguchi, Hironori</p> <p style="padding-left: 2em;">OP02-08</p> <p>Deguchi, Tomonori</p>
--	---	---	--

	P-136B	S02-01	Gustavsen, Carsten	Hasegawa, Shun P-143B
Deimling, Steven	WS2-10	Fukami, Yasuo	P-180B	Hasegawa, Takanori
Dominguez, Orlando		FT04-11 (P100B)	Gutierrez-Vallejo, Irene	FT01-13 (P148B)
	S01-03	Fukuda, Kimiko	OP04-06	Hasegawa, Tomoya
Donahue, Greg	WS2-05	SW1-02 (P134A)	H	OP02-11
Dong, Bo	P-177A	Fukui, Takashi P-017A	Hadjantonakis, Anna-Katerina	Hashimoto, Chikara
E		Fukuzawa, Masashi	WS2-10	SW1-06 (P173A)
Eaton, Suzanne	OP05-04	FT04-04 (P129A)	Hadjantonakis, Kat S03-04	Hashimoto, Hisashi
Ebisuya, Miki	S05-05	Funahashi, Akira S03-06	Hagiwara, Hiromi P-102A	OP02-10
Eeden, Freek van	S04-01	Funayama, Noriko	Hagiwara, Natsumi	Hashimoto, Naoki
Egawa, Ryo	P-072B	OP05-13	FT01-05 (P166A)	OP04-08
Egawa, Shiro	P-033A	// FT02-05 (P182A)	Hamachi, Misato S03-01	Hashimoto, Shota
Egelhofer, Thea	OP06-04	Furukawa, Tetsushi	Hamada, Hiroshi S04-03	SW2-07 (P094A)
Ejima, Chika	P-138A	OP06-06	Hamada, Yoshimasa	Haskel-Ittah, Michal
Elworthy, Stone	S04-01	Furukawa, Tomoyo	P-003B	S07-01
Ema, Masatsugu	OP06-10	P-051B	Han, Jin-Kwan P-126A	Hatori, Ryo OP07-01
Enomoto, Hideki	OP01-03	Furuta, Yasuhide	// P-127B	Hattori, Ayumi
// FT05-15 (P004B)		OP01-01	Han, Lili S04-04	FT02-07 (P186A)
Evans, Sylvia	OP01-04	Furutani, Tomoya	Han, Wonhee P-126A	// WS2-01
Ezura, Yoichi	OP07-09	P-017A	Han, Yi	Hayakawa, Itaru OP07-11
F		Futamura, Ryo	FT03-04 (P066A)	Hayashi, Katsuhiko
Faessler, R.		FT04-01 (P097A)	Hanan, Hamamy OP07-12	S08-05
FT03-01 (P061A)		G	Hanaoka, Fumio P-167B	Hayashi, Shigeo OP07-02
Falcon, Juan	S01-05	Gibson, Matthew S01-06	Hanaue, Mayu	// FT02-01 (P176B)
Felemban, Athary	OP02-05	Giovinazzo, Giovanna	FT04-15 (P096B)	// WS2-09
// FT05-16 (P002A)		S01-07	Hane, Lee OP07-12	// P-130A
Feng, Jing	S04-02	Gonzalez, Esperanza	Hara, Akira	// P-177A
Fernandez-Gonzalez, Rodrigo		S01-05	FT03-09 (P075B)	Hayashi, Shinichi
WS2-10		Goto, Akihiko	Hara, Ikuyo OP02-10	FT05-14 (P005A)
Fiedler, Bernold	OP01-09	FT04-10 (P097A)	Hara, Kenshiro	Hayashi, Tetsutaro
Fortini, Mark	OP03-02	Gradilla, Ana S01-05	FT05-15 (P004B)	OP02-06
Friedrich, Thomas		Grana, Osvaldo S01-03	Hara, Takahiko	// FT03-12 (P079B)
OP02-08		Grapin-Botton, Anne	FT02-09 (P192B)	// FT05-13 (P007B)
Fujii, Takeshi	P-136B	P-180B	Hara, Yuichiro	Hayashi, Toshinori
Fujimori, Toshihiko		Guerrero, Isabel S01-05	FT01-09 (P142A)	WS1-09
FT03-16 (P086A)		Gunaratne, Jayantha	Harada, Yumiko	Hayashi, Yoshiki S07-04
// P-170A		S04-01	FT03-03 (P065A)	Hayata, Tadayoshi
Fujimoto, Keita	P-110A	Guo, Pin	// P-110A	OP07-09
Fujimoto, Kiyoe	P-106A	FT02-02 (P178A)	Haramoto, Yoshikazu	Hemmmi, Natsuki
Fujimoto Koichi		Guo, Shengzhen	P-153A	OP04-11
FT02-11(P055B)		FT03-01 (P061A)	Harata, Masahiko P-163B	Henkelman, R. WS2-10
Fujita, Hironori		Guo, Xiaowei OP03-08	Hasebe, Mitsuyasu	Hibi, Masahiko OP02-10
SW1-05 (P049A)		Guo, Youhao	OP02-08	// OP04-04
Fujita, Toshiyuki P-064B		FT02-02 (P178A)	Hasegawa, Akira	// FT03-12 (P079B)
Fujiwara, Hironobu		Guo, Yueqin S04-04	SW2-03 (P154A)	// FT06-07 (P090A)

Higaki, Takumi	P-054A	P-155B	FT05-09 (P008B)	OP02-08
Higashidate, Takuya	P-006A	Hosoda, Kazutaka	Ikedada, Nobuhito	Ishikawa, Naoko
Higashijima, Shinichi	P-080B	Hosoi, Yoshihiko	Ikegami, Keisuke	Ishikura, Tomoyuki
Higuchi, Ryo	FT03-16 (P086A)	Hosokawa, Yoichiro	Ikenishi, Aiko	Ishitani, Shizuka
Hino, Hiromu	OP04-04	Hososhima, Shoko	Imanishi, Takeshi	Ishitani, Tohru
Hippo, Yoshitaka	P-136B	Hou, Yi	Inai, Mizuho	"
Hiraga, Chisato	FT01-12 (P146A)	Hozumi, Akiko	Ingham, Philip	Ishizuka, Masamichi
Hirai, Yohei	FT01-05 (P166A)	Hsieh, Chang-Huain	Inohaya, Keiji	P-102A
Hiramatsu, Ryuji	S07-05	Hsu, Hao-Jen	Inomata, Yukihiko	Ishizuka, Toru
Hirano, Hiroyuki	S06-04	Hu, Jiang	Inoue, Chikako	Isoda, Miho
Hirano, Shinji	OP01-04	Hu, Yujia	Inoue, Katsue	Isomura, Ayako
Hirasawa, Tatsuya	OP04-13	Huang, Guodong	Inoue, Kenichi	"
Hirashima, Tsuyoshi	OP05-08	Huang, I-Wen	Inoue, Kunio	Isono, Kyoichi
Hirayama, Miki	P-006A	Huang, Jian	Inoue, Osamu	Ito, Ayako
Hiromi, Yasushi	OP06-11	Huang, Jiuhong	Inoue, Osamu	Ito, Naofumi
Hirose, Shigehisa	P-040B	Huang, Szu-Jing	Inoue, Takeshi	"
Hisano, Yu	WS1-01	Hui, Chi Chung	Inoue, Takeshi	Itoh, Motoyuki
Hisatome, Ichiro	SW2-03 (P154A)	Hwang, Byulnim	"	"
Hiwatashi, Yuji	OP02-08	Hwang, Sheng-Ping	"	Itoh, Tohru
Ho, Kenneth	OP01-10	Hyodo, Susumu	"	Itoh, Yasuhiro
Holzer, Max	OP01-06	I	"	SW2-10 (P084B)
Hombria, James Castelli-Gair	OP05-09	Ichikawa, Rie	Inoue, Yusuke	Iwafuchi-Doi, Makiko
Homma, Daigo	OP07-11	Ichinohe, Noritaka	Inui, Chihiro	WS2-05
Honda, Akira	OP03-05	Ichinose, Hiroshi	Inui, Masafumi	Iwakura, Naohiro
Honda, Hisao	FT02-03 (P179B)	Igaki, Tatsushi	Irie, Naoki	Iwasaki, Tetsushi
Honda, Kurara	P-136B	Igarashi, Katsuhide	Iseki, Sachiko	FT04-11 (P100B)
Hopyan, Sevan	WS2-10	Iguchi, Sho	Ishibashi, Tomoki	Iyoda, Natsuko
Hor, Hong Huan	OP03-04	Iguchi, Taisen	"	J
Hori, Yutaro	OP06-06	Iguchi, Taisen	"	Jiang, Yun-Jin
Horita, Natsumi	SW2-09 (P022A)	"	"	Jin, Miaomiao
"	SW2-11 (P028B)	"	"	FT01-08 (P172B)
Hoshijima, Kazuyuki	OP07-06	Iimura, Naoya	"	Jing, Tian
Hoshino, Hideharu		Ikami, Kanako	"	OP07-12
			"	Julicher, Frank
			"	OP05-04
			"	K
			"	Kaestner, Klaus
			"	WS2-05
			"	Kagiwada, Saya
			"	SW1-07 (P031B)
			"	Kaido, Masako
			"	SW2-08 (P088B)

Kajihara, Takehiro OP06-11	Kawaguchi, Ayano FT03-07 (P073A)	// FT04-07 (P059B)	Kobayashi, Tetsuya S03-06
Kajikawa, Eriko P-157A	Kawaguchi, Eri FT05-06 (P014A)	Kazuyuki, Hoshijima P-043B	Koga, Akihiko WS1-05
// P-174A	// SW2-04 (P050A)	Kei, Nakayama S07-07	Kohara, Yu-hei P-175B
Kamei, Yasuhiro OP02-10	// WS1-09	Kelsh, Robert OP02-10	Kohchi, Takayuki FT02-02 (P178A)
Kamezaki, Aosa P-070A	Kawaguchi, Kohei OP06-11	Kida, Yasu-yuki P-135B	Koike, Hiroko FT04-16 (P095B)
Kamimoto, Kenji OP02-09	Kawaguchi, Masahumi SW2-05 (P087B)	Kidokoro, Hinako OP05-06	Kojima, Mizuyo OP06-06
Kan, Daphne Wei-Chun FT03-05 (P067B)	Kawaguchi, Masayoshi SW1-05 (P049A)	Kimori, Yoshitaka TW01-1	Kojima, Takuya P-158A
Kanai, Yoshiakira SW2-06 (P001A)	Kawahara, Atsuo WS1-01	Kimpara, Akiyo OP07-02	Kondo, Kaori OP06-03
Kanazawa, Yasuko OP05-03	Kawahara, Hiroyuki SW1-02 (P134A)	Kimura, Seisuke FT06-12 (P111B)	Kondo, Mao P-033A
Kaneko, Kota OP02-09	Kawai, Kotoe OP05-13	Kimura, Tetsuaki OP02-10	Kondo, Mariko WS1-05
Kanemaru, Yumi P-138A	Kawai, Mitsuru P-017A	Kimura-Yoshida, Chiharu S07-05	Kondo, Takashi OP06-03
Kanno, Jun SW1-10 (P133A)	Kawakami, Atsushi OP02-11	Kinoshita, Keiji FT01-01 (P150A)	Kondo, Takefumi WS2-09
Kasajima, Ippei P-040B	// SW2-09 (P022A)	Kinoshita, Tsutomu P-109A	Kondoh, Hisato OP04-07
Kashima, Makoto FT05-06 (P014A)	// SW2-11 (P028B)	// P-143B	// P-047B
// FT05-08 (P012B)	Kawakami, Koichi OP01-07	Kishigami, Satoshi P-163B	Konishi, Hidenori P-168B
// SW2-04 (P050A)	// OP05-01	Kishimoto, Keishi FT06-13 (P108B)	Kose, Hiroyuki OP06-11
Kashiwabara, Shin-ichi P-102A	// FT03-12 (P079B)	Kishimoto, Kouji FT02-05 (P182A)	Koseki, Haruhiko OP06-03
Katahira, Tatsuya FT03-06 (P071B)	// FT06-07 (P090A)	Kita, Tomoko OP03-05	// FT01-13 (P148B)
Katayama, Kentaro FT06-08 (P123B)	// SW2-09 (P022A)	Kitadate, Yu OP06-10	// P-037A
Kato, Kagayaki TW01-2	// P-080B	Kitazawa, Taro OP04-13	Koshiba, Kazuko OP06-06
Kato, Kentaro P-062A	// SW2-11 (P028B)	// P-191B	Koshiba-Takeuchi, Kazuko S01-02
Kato, Suguru SW2-04 (P050A)	Kawamura, Kazuki FT02-04 (P181A)	Kiyonari, Hiroshi FT03-07 (P073A)	// WS2-08
Kato, Yuzuru OP06-08	Kawamura, Yumiko P-191B	// P-155B	Koya, Yasunori FT04-10 (P097A)
Katou, Yuki FT05-03 (P025A)	Kawano, Rie OP02-05	Kiyozumi, Daiji OP02-04	Koyanagi, Ryo OP04-09
Katow, Hidetaka P-072B	// FT05-11 (P009A)	Knoblich, Juergen FT06-15 (P104B)	Kozuka-Hata, Hiroko P-064B
Katsumoto, Keiichi P-180B	// FT05-16 (P002A)	Kobayashi, Ayana P-119B	Kreher, Jeremy OP06-04
Katsuyama, Kayoko FT01-13 (P148B)	// SW1-03 (P107B)	Kobayashi, Chie P-158A	Kuan, Yung-Shu FT03-08 (P074A)
Kawade, Kensuke FT04-05 (P128B)	Kawasaki, Hiroshi OP07-11	Kobayashi, Manami P-109A	Kubo, Shiori OP03-01
Kawaguchi, Akane FT05-10 (P011B)	Kawasaki, Takashi P-136B	Kobayashi, Satoru S07-04	Kubo, Takeo FT05-03 (P025A)
	Kawasumi, Aiko FT05-02 (P029A)	// S08-01	// P-064B
	Kawaue, Takumi FT03-07 (P073A)	// S08-02	Kudo, Akira OP02-02
			// OP02-11
			// SW2-09 (P022A)
			// SW2-11 (P028B)
			Kumagai, Nobuyoshi

OP02-06	Kusakabe, Rie	OP04-10	Li, I-Chen	Maeno, Akiteru
" FT05-08 (P012B)	Kusunoki, Susumu		FT03-10 (P076B)	FT06-09 (P116B)
Kume, Hideaki	SW2-01 (P068B)		Li, Li	WS2-05
Kume, Kazuhiko	Kutejova, Eva	S07-02	Li, Yi-Chin	Makanae, Aki
FT06-10 (P115B)	Kutsuna, Natsumaro		FT04-08 (P056B)	"
Kume, Shoen	TW01-3		Li, Zhouhua	P-015B
FT06-10 (P115B)	"	P-054A	Liao, Meng-Lin	"
"	Kuwana, Satoshi		FT03-05 (P067B)	Mantoku, Akiko
Kumon, Mami	FT04-04 (P129A)		Lin, Gee-Way	OP02-02
Kunieda, Takekazu	Kwan, Kin Ming		FT04-12 (P101A)	Manzanares, Miguel
FT05-03 (P025A)	FT03-11 (P077A)		Lin, Li-Yi	S01-03
Kunimasa, Kei	"	FT06-05 (P092B)	FT01-02 (P159B)	Maria, Barna
OP07-03	Kyoda, Koji	OP01-10	Lin, Ming-Der	S07-03
Kunisada, Takahiro	L		FT01-02 (P159B)	Marti, Elisa
FT03-09 (P075B)	Lacroix, Christian		"	OP04-06
Kunita, Itsuki	FT02-13 (P197A)		"	Martinez, Dolores
S05-04	Ladher, Raj	OP03-05	Lin, Shuo	S01-03
Kuraku, Shigehiro	"	OP05-05	Lin, Wei-Hsiang	Maruyama, Aumi
OP04-12	Lai, Kp	P-184B	FT03-10 (P076B)	
"	Lang, Wei-Han		Lin, Xinhua	OP06-10
FT01-09 (P142A)	FT03-08 (P074A)		Ling, Ling	Masai, Ichiro
"	Lau, Kimberly	WS2-10	OP07-12	OP07-07
"	Lau, Marco CC		Liu, Chia-Ying	Masaki, Hideki
"	FT02-06 (P185A)		P-057A	S02-06
Kuranaga, Erina	Lau, Yi-Yan		Liu, Fu-Chin	Masuda, Miwa
OP05-11	FT03-10 (P076B)		OP01-04	OP07-05
"	Laux, Thomas	OP02-08	Liu, Haijiao	Masuda, Shinji
P-183B	Lazic, Savo	WS2-10	WS2-10	OP01-11
Kurata, Tetsuya	Lee, Dolim	WS2-05	Lu, Huiqiang	Masuda, Tomoyuki
OP02-08	Lee, Hayoung		S04-05	
Kuratani, Shigeru	FT05-07 (P013A)		Lu, Kuan-Ming	P-078A
OP04-13	"	SW2-04 (P050A)	OP01-04	Masui, Shinji
"	Lee, Hung-Chieh	P-038A	Luo, Lingfei	WS2-04
"	Lee, Raymond	S04-01	S04-05	Matano, Mami
WS1-06	Lee, S. Seirin		Luo, Yi-Jyun	S02-04
"	FT04-09 (P052B)		OP07-07	Matsubara, Yoshiyuki
P-147B	Leung, Crystal Kit-Ying		S04-02	FT02-04 (P181A)
Kurihara, Hiroki	FT06-05 (P092B)		M	"
OP04-13	Levi, Giovanni	OP04-13	Ma, Jun	FT02-07 (P186A)
"	"	P-191B	S04-05	"
"	Lee, Hung-Chieh	P-038A	Ma, Tsz Ching	WS2-01
"	Lee, Raymond	S04-01	FT03-11 (P077A)	Matsuda, Koji
"	Lee, S. Seirin		OP03-10	FT03-12 (P079B)
Kuroiwa, Atsushi	FT04-09 (P052B)		OP03-11	Matsuda, Masaru
FT02-04 (P181A)	Leung, Crystal Kit-Ying		Maeda, Ikuma	P-117A
"	FT06-05 (P092B)		S08-06	Matsuda, Yoichi
"	Levi, Giovanni	OP04-13	Maeda, Kazuhiro	FT01-01 (P150A)
"	"	P-191B	OP04-13	"
"	Levitt, Pat	P-114A	Maeda, Yuka	FT02-04 (P181A)
"	Li, Cai	P-033A	FT05-06 (P014A)	Matsui, Takaaki
Kurokawa, Daisuke	Li, Danyi	WS2-10	"	OP07-05
P-032B	Li, Han-Ru		Maehara, Kazumitsu	"
"	FT01-02 (P159B)		WS1-07	SW1-01 (P156B)
"			WS1-07	Matsui, Yasuhisa
"			OP05-11	S08-06
"			P-183B	"
"				OP06-07
"				Matsuka, Yuji
"				WS1-03
"				Matsukawa, Shinya
"				P-051B
"				"
"				P-162A
"				Matsumoto, Takeo
"				FT06-16 (P103B)
"				Matsumoto, Yudai
"				S03-01
"				Matsuno, Kenji
"				OP03-01
"				"
"				OP03-02

"	OP07-01	FT04-15 (P096B)	S02-02	OP06-10		
"	FT06-16 (P103B)	Miwa, Naoki	"	FT06-11 (P112B)	Nagayama, Chikashi	
Matsuo, Isao	S07-05	FT04-10 (P097A)	"	FT06-13 (P108B)	FT05-02 (P029A)	
Matsuoka, Yuji	P-160B	Miwa, Takashi	Morino, Yoshiaki		Nagayama, Masaharu	
Matsuura, Naoki	P-017A	SW1-04 (P039B)	OP04-08		OP01-08	
Matsuura, Yoshimi	P-017A	Miwa, Toru P-114A	Morishita, Shinichi	WS1-05	"	FT03-16 (P086A)
Matta, Tatsuro		Miyagawa, Shinich	Morita, Shinichi		Nakagaki, Toshiyuki	
	SW1-01 (P156B)	FT04-14 (P098A)		S05-04		
Maurya, Ashish	S04-01	Miyagawa-Tomita, Sachiko	FT01-12 (P146A)		Nakagawa, Reiko	
Megias, Diego	S01-03	OP04-13	Morita, Toshiharu	P-017A	OP03-05	
Meicenheimer, Roger		Miyagi, Hisako	Morita, Yuika	WS2-08	Nakajima, Keiji	
	FT02-13 (P197A)	Miyajima, Atsushi	Moriyama, Yuki	P-162A	Nakajima, Teruhiro	
Meno, Chikara	WS1-07	OP02-09	Moriyama, Yuuta	S01-02	OP02-11	
Miao, Guangxia	P-130A	Miyamoto, Tatsuo	Moroka, Mayu	P-113A	Nakajima, Yuichiro	
Michiue, Tatsuo		FT01-06 (P169A)	Mosteiro, Lluç	S01-03	S01-06	
	FT02-09 (P192B)	Miyasaka, Kota P-045A	Motoyama, Jun	OP01-02	Nakamasu, Akiko	
"	P-162A	"	"	OP05-10	FT06-12 (P111B)	
Mii, Yusuke	S07-07	Miyasaka, Nobuhiko	"	FT03-06 (P071B)	Nakamura, Jun	
"	FT04-03 (P131B)	FT03-12 (P079B)	Mouri, Kousuke		SW2-02 (P018A)	
"	P-139B	Miyata, Takaki	FT06-03 (P041A)		Nakamura, Nobuhiro	
Mikami, Yoshikazu		FT03-07 (P073A)	Mtatsui, Takaaki		P-040B	
	OP02-07	"	SW1-09 (P118A)		Nakamura, Ryo	
Misaki, Kazuyo	OP03-05	"	Mukai, Takahiko		OP06-06	
"	OP05-11	"	FT04-10 (P097A)		Nakamura, Takafumi	
"	FT02-01 (P176B)	Mizoguchi, Takamasa	Mukaigasa, Katsuki		SW2-03 (P154A)	
Mitani, Tasuku	P-163B	P-080B	FT03-13 (P081A)		Nakanishi, Akira	
Mito, Taro	WS1-03	Mizumoto, Kanako	Mummery-Widmer, Jennifer		P-167B	
"	P-003B	P-046A	FT06-15 (P104B)		Nakano, Itsuko	
"	P-160B	Mizushina, Yoichi	Munakata, Keijiro		OP02-04	
"	P-187B	FT06-09 (P116B)	P-040B		Nakano, Mikiharu	
Mitogawa, Kazumasa		Mizutani, Makoto	Murakami, Ryutaro		FT01-01 (P150A)	
	S09-03	FT01-01 (P150A)	FT03-03 (P065A)		"	
"	P-015B	Mizutani-Koseki, Yoko	"	P-110A	FT02-04 (P181A)	
"	P-016B	FT01-13 (P148B)	Murali, Deepa	OP01-01	Nakanoh, Shota	
Mitsui, Silvia	P-187B	Mochizuki, Atsushi	Murata, Takashi	OP02-08	FT05-05 (P019B)	
Mitsui, Toshiyuki		OP01-09	Myouga, Ayumi	WS1-09	Nakao, Kazuki	
	FT06-14 (P105A)	Mochizuki, Toshiaki	N		P-155B	
Miura, Masayuki	S03-01	OP07-07	Nag, Kakon	P-040B	Nakata, Hiroshi	
Miura, Naoyuki	P-189A	Mogi, Makoto	Nagano, Mamoru		SW2-10 (P084B)	
Miura, Takashi	S07-06	Mohammad, Shboul	SW2-01 (P068B)		Nakatani, Yuki	
"	OP01-08	OP07-12	Nagao, Yusuke	OP02-10	OP01-11	
"	FT03-16 (P086A)	Mohri, Yasuaki	Nagasaka, Arata		Nakato, Ryuichiro	
"	P-054A	P-020B	FT03-16 (P086A)		OP05-03	
Miwa, Naofumi		"	"	P-083B	Nakaura, Mizuki	
		Morimoto, Kenta	Nagasawa, Takashi		P-042A	
		P-162A			Nakaya, Masataka	
		Morimoto, Mitsuru			P-163B	
					Nakaya, Yukiko	
					WS2-06	
					Nakayama, Ayako	
					OP02-07	
					Nakayama, Hokuto	
					FT06-12 (P111B)	
					Nakayama, Yuki	
					P-023B	

Nakazawa, Naotaka	Noji, Sumihare	WS1-03	Ohta, Kunimasa	OP02-05	Onoe, Hiroaki	S09-05
FT06-16 (P103B)	"	P-003B	"	FT05-11 (P009A)	Onuma, Yasuko	P-153A
Nanayama, Ryuji	"	P-160B	"	FT05-16 (P002A)	"	P-189A
FT03-14 (P082A) (P141A)	"	P-187B	"	SW1-03 (P107B)	Oonuma, Kouhei	OP04-02
Narboux-Neme, Nicolas	Nonomura, Keiko	S03-01	Ohta, Toshihiro		Ootani, Yuuki	P-143B
OP04-13	Noro, Miyuki		FT01-12 (P146A)		Orihashi, Kaoru	P-136B
Narboux-Nme, Nicolas	FT01-09 (P142A)		Ohta, Yuki	S02-04	Ors, Inmaculada	S01-03
P-191B	"	P-157A	Ohtsuka, Eri	P-102A	Ortega, Sagrario	S01-03
Naruse, Kiyoshi	OP02-10	S03-04	Ohuchi, Hideyo	P-003B	Oshima, Kenzi	OP07-02
"	WS1-05		Ohyama, Takahiro	P-114A	Osumi, Noriko	
Newmark, Phillip	S08-04	FT03-14 (P082A)	Oka, Sanae	P-170A	FT04-07 (P059B)	
Ng, Vivian	P-140B	O	Okabe, Masaru	P-102A	"	SW2-05 (P087B)
Nieto, Angela	S01-01	Obika, Satoshi	Okabe, Masataka	OP05-06	Ota, Satoshi	OP04-05
Niimi, Teruyuki	WS2-07	Ochi, Haruki	"	P-120B	"	WS1-01
Ninomiya, Hiromasa		FT05-10 (P011B)	Okamoto, Mayumi		Otani, Tetsuhisa	OP07-02
FT02-08 (P188B)	"	P-034A	FT03-07 (P073A)		Otsuka, Rina	
Nishida, Eisuke	P-151B	"	P-043B	"	FT05-02 (P029A)	
Nishimiya-Fujisawa, Chiemi		Oda, Hiroki	OP04-11	"	P-083B	
S08-02	"	FT04-06 (P125A)	Okamoto, Naoki	OP03-06		FT03-10 (P076B)
Nishimori, Hiraku		Odaka, Mirei	"	P-132B	Oyadomari, Seiichi	
FT01-06 (P169A)		Ogaki, Soichiro	Okamoto, Ryuji	P-047B		P-187B
Nishimori, Katsuhiko		FT06-10 (P115B)	Okamura, Yoshiaki		Oyama, Kazunori	P-020B
P-020B	"	P-113A	WS1-02		"	P-196B
"	P-196B	Ogino, Hajime	Okanao, Makoto	P-080B	Oyama, Masaaki	P-064B
Nishimura, Osmou		FT05-10 (P011B)	Okashita, Naoki	OP06-05	Ozaki, Yukio	
FT05-13 (P007B)	"	P-034A	"	SW2-02 (P018A)	SW1-08 (P121A)	
Nishimura, Takashi	"	P-043B	Okayama, Hitomi	OP07-04	Ozawa, Akio	OP02-04
OP03-06	Ogino, Yukiko		Oki, Shinya	WS1-07	Ozekii, Mitsunori	S03-06
"	FT04-14 (P098A)		Okigawa, Sayumi	P-080B	P	
Nishinakamura, Ryuichi	Ogura, Toshihiko		Okubo, Tadashi	P-044B	Pan, Hailin	P-033A
OP02-01	FT02-07 (P186A)		Okubo, Yusuke		Pantoja, Cristina	S01-03
"	WS2-01		SW1-10 (P133A)		Pascual-Anaya, Juan	
"	P-045A		Okudaira, Keiko		WS1-06	
"	P-058A		FT03-14 (P082A) (P141A)		P-147B	
Nishiura, Yasumasa	Ohata, Yoshihisa	P-162A	Omori, Hisayoshi		Pelegri, Francisco	
S05-04	Ohkawa, Yasuyuki		FT06-10 (P115B)		OP04-04	
Nishiyama, Tomoaki	WS1-07		Onai, Takayuki		Peng, Fei	
OP02-08	Ohkura, Masamichi		FT01-03 (P164B)		FT03-15 (P085A)	
Niu, Pengfei	FT03-12 (P079B)		Onami, Shuichi	OP01-10	Perez-Pulido, Antonio	
P-124B	Ohmomo, Hideki	P-078A	"	OP06-12	P-147B	
Niwa, Taiki	Ohmura, Tomomi	P-032B	Onimaru, Koh	OP04-12	Prasitsak, Thanit	OP07-10
FT04-10 (P097A)	Ohnishi, Hiroe	P-136B	Onishi, Akira	P-174A	Pugh, Franklin	WS2-05
Noda, Masaki	OP07-09		Onodera, Nozomi		Pui, Han Pin	
Noguchi, Junko	P-102A	Ohsawa, Shizue	OP07-03		FT04-13 (P099B)	
Noguchi, Masafumi	"	FT02-11(P055B)	"	FT03-14 (P082A)		
FT06-11 (P112B)	Ohshima, Hiroataka	P-102A	"	SW2-10 (P084B)		

R		OP06-04	"	P-015B	"	FT05-08 (P012B)	
Rayon, Teresa	S01-03	"	SW1-04 (P039B)	"	P-016B	"	SW2-04 (P050A)
Rechtsteiner, Andreas		Sakamoto, Kousuke		Satoh, Nori	OP04-09	Shibata, Shumei	P-114A
	OP06-04		WS1-09	Satoh, Yukio	OP07-04	Shibata, Tatsuo	
Reisewitz, Pascal		Sakamoto, Naoaki		Sato-Nishiuchi, Ryoko			FT04-09 (P052B)
	OP02-08		FT01-06 (P169A)		OP02-04	Shibuya, Hiroshi	OP03-03
Ren, Pu	OP03-07	Sakane, Yuto		Sawa, Hitoshi	OP05-07	Shida, Hiroko	
Ren, Shukun	OP01-11		FT06-02 (P053A)	"	FT04-01		FT04-07 (P059B)
Rensing, Stefan	OP02-08	Sako, Norihisa	P-102A	Sawa, Shinichiro	S06-02	Shiga, Yasuhiro	
S		Sakuma, Chie	P-078A	"	P-138A		FT01-12 (P146A)
Sánchez-Higuera, Carlos		Sakuma, Tetsushi		Schejter, Eyal	S07-01	Shigeyama, Erina	OP06-04
	OP05-09		FT06-02 (P053A)	Schier, Alexander	PL-01	Shigeyoshi, Yasufumi	
Sadek, Hesham	OP06-06	"	WS1-08	Schoenwolf, Gary	OP05-06		SW2-01 (P068B)
Saga, Yumiko	OP06-08	"	WS1-09	Scott, Ian	WS2-10	Shilo, Benny	S07-01
"	OP06-09	"	WS1-10	Sehara-Fujisawa, Atsuko		Shimada, Atsuko	WS1-05
"	FT04-13 (P099B)	Sakurai, Yusuke	P-032B		P-070A	Shimamura, Hisanobu	
"	FT04-16 (P095B)	Sari, Dini	OP07-05	Seki, Ryohei	P-033A		OP05-03
"	FT05-01 (P030A)	Sasai, Noriaki	S07-02	Seki, Ryoko	OP02-10	Shimizu, Atsushi	P-035B
"	FT06-01 (P048B)	Sasaki, Haruka	WS1-08	"	OP04-04	"	OP02-10
"	SW1-10 (P133A)	Sasaki, Junko		Seki, Yoshiyuki	OP06-05	Shimizu, Miki	P-191B
"	WS1-02		FT06-15 (P104B)	"	SW2-02 (P018A)	Shimizu, Nobuyoshi	
Sagai, Tomoko	OP06-02	Sasaki, Takehiko		"	SW2-07 (P094A)		P-035B
"	FT06-03 (P041A)		FT06-15 (P104B)	Sekiguchi, Kiyotoshi		Shimizu, Nobuyuki	
"	FT06-09 (P116B)	Sasaki, Yuko	P-043B		OP02-04		OP03-03
Sago, Ken		Sasakura, Yasunori		Semi, Katsunori	P-027B	Shimizu, Takashi	
	FT03-07 (P073A)		WS1-08	Senoo, Haruki			OP04-04
Sai, Xiao Rei	OP05-05	Sasamura, Takeshi			FT06-15 (P104B)	"	FT03-12 (P079B)
Saiga, Hidetoshi	OP04-01		OP03-02	Serrano, Manuel	S01-03	"	FT06-07 (P090A)
"	OP04-02	Sasano, Tetsuo	OP06-06	Serup, Palle	P-180B	Shimizu, Yoshiko	P-035B
Saigoh, Kazumasa		Sato, Atsushi	OP03-03	Sham, Mai Har	OP03-04	Shimoda, Takahiro	
	SW2-01 (P068B)	Sato, Eiji	P-189A	Shan, Jingdong	P-180B		P-020B
Saijoh, Yukio	OP05-06	Sato, Eriko	P-045A	Shao, Yingyao	OP03-11	Shimokawa, Mariko	
Saito, Yohei	P-158A	"	P-058A	Sharif, Jafar			S02-04
Saitou, Mitinori	S08-05	Sato, Fuminori	P-070A		FT01-13 (P148B)	Shimomura, Keita	P-017A
"	SW1-07 (P031B)	Sato, Makoto	OP01-08	Sheng, Guojun		Shimono, Chisei	OP02-04
Sakai, Atsushi		"	SW2-08 (P088B)		FT02-07 (P186A)	Shimono, Fumie	
	FT02-07 (P186A)	Sato, Tempei	P-190A	"	WS2-01		FT01-06 (P169A)
"	WS2-01	Sato, Tomohiko	P-033A	"	WS2-06	Shimozuru, Kentaro	
Sakai, Daisuke	OP05-10	Sato, Toshiro	S02-04	Shi, Lai	S04-04		P-023B
Sakai, Yoshifumi		Sato, Yoshikatsu	OP02-08	Shi, Wenchao	S04-05	Shimura, Satoru	
	FT02-14 (P198A)	Sato, Yuka	P-051B	Shibata, Eri			SW1-02 (P134A)
Sakakibara, Keiko		Sato, Yuki			SW2-09 (P022A)	Shinmyo, Yohei	OP02-05
	OP02-08		FT05-04 (P021A)	Shibata, Norito	OP02-06	Shinoda, Tomoyasu	
"	FT02-02 (P178A)	Sato, Yuya	OP02-04	"	FT05-04 (P021A)		FT03-07 (P073A)
Sakamoto, Hiroshi		Satoh, Akira	S09-03	"	FT05-07 (P013A)	"	FT03-16 (P086A)

"	P-083B	Suda, Yoko	P-032B	FT02-09 (P192B)	Takahashi, Minoru
Shinomiya, Ai		Sudou, Norihiro		Suzuki, Makoto	OP05-12
	FT01-01 (P150A)		FT05-10 (P011B)	Suzuki, Marianna	Takahashi, Naoki
Shinotsuka, Naomi	S03-01	Suematsu, Makoto		FT02-09 (P192B)	Takahashi, Satoru
Shinozuka, Takuma	S07-07		P-136B	Suzuki, Miyuki	OP06-10
"	FT01-04 (P165A)	Suematsu, Nobuhiko		FT06-02 (P053A)	Takahashi, Shuji
Shinzato, Chuya	OP04-09		FT06-12 (P111B)	Suzuki, Nanoka	P-153A
Shioi, Go	P-155B	Sugahara, Fumiaki		Suzuki, Shohei	OP07-07
Shirahige, Katsuhiko			P-147B	Suzuki, Takayuki	
	OP05-03	Sugimoto, Ryo		FT02-04 (P181A)	S01-04
"	FT05-03 (P025A)		FT05-09 (P008B)	"	FT02-07 (P186A)
Shirai, Toshiaki		Sugimoto, Yukihiko		"	WS2-01
	SW1-08 (P121A)		OP07-11	Suzuki, Takumi	
Shirakami, Akari		Sugita, Syukei		SW2-08 (P088B)	Takamatsu, Ken
	SW2-07 (P094A)		FT06-16 (P103B)	Suzuki, Tohru	FT04-15 (P096B)
Shiraki, Nobuaki		Sugiura, Misa	P-109A	FT02-14 (P198A)	Takano, Ai
	FT06-10 (P115B)	Sugiura, Yuki	P-136B	"	S02-04
"	P-113A	Sugiyama, Arisa	S07-04	"	Takano, Tomomi
Shirayoshi, Yasuaki		Sugiyama, Chika	P-010A	T	
	SW2-03 (P154A)	Sugiyama, Fumihiko		Tachibana, Makoto	OP01-05
Shiroishi, Toshihiko			OP06-10	WS2-03	Takaoka, Katsuyoshi
	OP06-02	Sukowati, Erike W.		Tagawa, Takashi	OP04-03
"	FT06-03 (P041A)		WS2-06	FT01-05 (P166A)	Takaoka, Sho
"	FT06-09 (P116B)	Sultana, Naznin	P-040B	Taguchi, Atsuhiko	P-167B
Shoji, Wataru		Sumino, Eri		OP02-01	Takasaki, Teruaki
	FT06-06 (P091B)		SW1-01 (P156B)	Tahara, Naoyuki	OP06-04
Sierra, Rocio	S01-07	Sumiya, Eri		SW1-01 (P156B)	"
Simons, Benjamin			FT04-14 (P098A)	"	OP04-02
	FT05-15 (P004B)	Sun, Fei	P-193A	SW1-09 (P118A)	Takayama, Jun
So, Shuhei	OP05-07	Sun, Yu	WS2-10	Taira, Masanori	OP06-12
Song, Xiaohong		Susuter, Maximiliano		Takada, Hitomi	Takayama, Rie
	FT05-16 (P002A)		P-080B	Takada, Ritsuko	SW2-08 (P088B)
Sorfazlian, Natalie		Suto, Fumikazu		FT01-04 (P165A)	Takebayashi-Suzuki, Kimiko
	WS2-10		SW2-05 (P087B)	Takada, Shinji	P-168B
Sotillos, Sol	OP05-09	Suzuki, Atsushi	S02-03	"	OP07-06
Stoeger, Thomas		"	P-168B	"	FT01-04 (P165A)
	FT06-15 (P104B)	Suzuki, Daichi		"	FT04-03 (P131B)
Strasser, Neta	S07-01		FT01-14 (P149A)	"	FT06-07 (P090A)
Strome, Susan	OP06-04	Suzuki, Hiroetsu		"	P-044B
Sturgeon, Kendra			FT06-08 (P123B)	Takada, Shuji	P-190A
	WS2-10	Suzuki, Hirobumi	P-036B	Takagi, Masaki	
Su, Yi-Hsien			WS1-10	FT04-10 (P097A)	Takemura, Shota
	FT01-02 (P159B)	Suzuki, Kenichi		Takagi, Shin	FT05-06 (P014A)
Suda, Hiroko	OP07-08	Suzuki, Ken-ichi		Takagi, Wataru	S01-02
Suda, Natsumo	OP05-03		FT06-02 (P053A)	Takahashi, Masanori	"
		Suzuki, Kenji		P-089A	OP06-06
					Takeuchi, Jun K.
					"
					WS2-08
					Takeuchi, Miki
					FT03-12 (P079B)

" FT06-07 (P090A)	FT04-05 (P128B)	FT02-06 (P185A)	S09-01
Takeuchi, Takashi	Tao, Hirotaka WS2-10	Tse, Wkf P-184B	" OP01-05
OP07-04	Tateishi, Satoshi P-010A	Tsuboi, Alice OP07-01	" OP02-12
" WS1-09	Tatsumi, Norifumi P-120B	" FT02-11(P055B)	" FT05-13 (P007B)
Takeyasu, Megumi	Tatsumi, Yoshinari	Tsudzuki, Masaoki	Umetsu, Daiki OP05-04
FT03-03 (P065A)	P-117A	FT02-04 (P181A)	Urata, Yuko P-026A
Takigawa-Imamura, Hisako	Tazaki, Akira S09-02	Tsuge, Shoichiro OP07-05	Uriu, Koichiro OP05-02
P-054A	Tochigi, Yuki	Tsujioka, Hiroshi	V
Tamada, Yosuke OP02-08	FT06-08 (P123B)	FT05-03 (P025A)	Vainio, Seppo P-180B
Tamano, Moe P-190A	Tochinai, Shin OP02-07	Tsukahara, Yuko OP06-06	Viotti, Manuel S03-04
Tamura, Koji OP05-06	Toda, Tomohisa OP07-11	" WS2-08	Vong, Keng Ioi
" FT05-02 (P029A)	Tohsato, Yukato OP01-10	Tsukaya, Hirokazu	FT06-05 (P092B)
" FT05-14 (P005A)	Tokishita, Shinichi	S06-01	W
" P-006A	FT01-12 (P146A)	" FT02-02 (P178A)	Wada, Hironori OP05-01
" P-033A	Tokmakov, Alexander	Tsukiji, Nagaharu	Wada, Hiroshi OP04-08
Tamura, Norihisa P-102A	FT04-11 (P100B)	SW1-08 (P121A)	" FT01-14 (P149A)
Tamura, Shogo	Tokue, Moe	Tsukioka, Aimi OP05-11	Wada, Yoh S03-03
SW1-08 (P121A)	FT05-09 (P008B)	" P-183B	Wakamatsu, Yoshio
Tamura, Yuka P-043B	" FT05-12 (P024B)	Tsumagari, Kazuya	FT04-07 (P059B)
Tan, Zhijia P-140B	Tokunaga, Tomoyuki	P-070A	Wakamatsu, Yuko
Tanaka, Akito P-027B	P-174A	Tsutsumi, Rio OP02-03	OP02-10
Tanaka, Eiji P-187B	Tokuoka, Hirofumi	Tzeng, Bo-Wei	Wan, Ht P-184B
Tanaka, Haruna P-080B	OP07-11	FT03-10 (P076B)	Wang, Bo S08-04
Tanaka, Hideaki OP02-05	Tomioka, Kenji P-003B	U	Wang, Boshi OP03-04
" FT05-16 (P002A)	Tong, Ka Kui	Uchijima, Yasunobu	Wang, Guo-Tzau
Tanaka, Hiroki P-119B	FT03-11 (P077A)	P-191B	FT03-08 (P074A)
Tanaka, Mikiko OP01-11	Tonoyama, Yasuhiro	Uchikawa, Masanori	Wang, Haibin S03-02
" OP04-12	P-035B	P-047B	Wang, Han OP06-01
" OP05-03	Torii, Keiko U. S05-03	Uchiyama, Hideho	" P-060B
Tanaka, Satomi OP06-07	Torres, Miguel S01-07	FT01-10 (P144B)	" P-124B
Tanaka, Satoshi OP02-04	Toshima, Asuka OP02-07	Uchiyama, Ikuo	Wang, Hong
Tanaka, Yumiko P-040B	Toyooka, Yayoi P-170A	FT05-14 (P005A)	FT01-08 (P172B)
Tane, Shoji OP07-04	Treen, Nicholas WS1-08	Ueda, Kei-ichi S05-04	Wang, Mingyong P-124B
Tanegashima, Kosuke	Tsai, Huai-Jen P-038A	Ueda, Nami P-010A	Wang, Nan-Kai
FT02-09 (P192B)	Tsang, Horace S04-06	Ueda, Shogo OP05-03	FT03-05 (P067B)
Tang, Hoi Ching S04-06	Tsang, Kwok P-140B	Ueda, Shuichi P-078A	Wang, Szu-Chieh
Tang, Lili P-060B	Tsang, Kwok Yeung	Ueno, Naoto OP05-12	FT04-12 (P101A)
Tani, Saori OP04-10	S04-06	Uesaka, Toshihiro	Wang, Xingjun
Taniguchi, Masahiko	Tsang, Wai Hung	OP01-03	FT03-04 (P066A)
P-078A	FT03-02 (P063B)	Uezato, Tadayoshi	" FT06-04 (P093A)
Taniguchi, Yoshihito	" P-063B	P-189A	Wang, Yi-Yun
OP02-10	" P-193A	Uji, Susumu P-161A	FT03-10 (P076B)
Taniguchi, Yukimasa	Tse, William Ka Fai	Umeda, Keiko	Wang, Yu-Chiun S05-01
OP02-04	FT02-10 (P194A)	FT06-06 (P091B)	Wang, Zhiqiang
Tanimoto, Hirokazu	Tse, William KF	Umesono, Yoshihiko	FT06-04 (P093A)

Wanglar, Chimwar	FT01-08 (P172B)	"	P-174A	Yeung, Bhy	P-184B
OP07-06	Xudong, Huang S04-04	Yamamoto, Kimiko		Yin, Xiaofeng	
Watanabe, Minoru	Xue, Lei OP03-07		S05-02	FT02-13 (P197A)	
FT01-07 (P171B)	" OP03-08	Yamamoto, Masamichi		Yokoi, Hayato	
Watanabe, Miwa	" OP03-09		WS2-02	FT02-14 (P198A)	
SW2-10 (P084B)	" OP03-10	"	P-167B	"	P-161A
Watanabe, Takahito	" FT01-11 (P145A)	Yamamoto, Takashi		"	P-117A
WS1-03	" FT03-04 (P066A)		OP07-06	Yokoi, Masayuki	P-167B
" P-160B	" FT03-15 (P085A)	" FT01-06 (P169A)		Yokota, Yuki	
Watanabe, Takehiro	" FT06-04 (P093A)	" FT06-02 (P053A)		SW2-11 (P028B)	
P-136B	Y	"	WS1-08	Yokotani, Naoki	WS1-09
Watanabe, Yusuke	Yabe, Taijiro OP07-06	"	WS1-09	Yokouchi, Yuji	OP07-08
FT02-07 (P186A)	Yagi, Masaki P-027B	"	WS1-10	Yokoyama, Hitoshi	
" WS2-01	Yaginuma, Hiroyuki	Yamamoto, Takayoshi		FT05-02 (P029A)	
Watts, Jason	FT03-13 (P081A)		P-139B	" FT05-14 (P005A)	
Wen, Jun	" P-078A	Yamamoto-Shiraishi, Yo-ichi		"	P-006A
Werr, Wolfgang	Yajima, Mamiko S08-03		P-122A	Yomogida, Kentaro	
Wessel, Gary	Yamada, Gen	"	P-175B		P-010A
S08-03	FT04-14 (P098A)	Yamamura, Ken-ichi		Yonemura, Shigenobu	
Wilkinson, David	Yamada, Mari		OP07-08		OP03-05
P-089A	FT01-07 (P171B)	Yamanaka, Shinya		"	OP05-11
Williams, Trevor	Yamada, Ryo OP05-03		P-027B	"	FT02-01 (P176B)
WS2-10	Yamada, Sohei	Yamashita, Wataru		"	FT06-07 (P090A)
P-027B	SW1-01 (P156B)		P-026A	Yoshida, Kaoru	P-102A
Wong, Ckc	Yamada, Takayuki	Yamashita, Yui	OP01-01	Yoshida, Keita	WS1-08
P-184B	P-132B	Yamasu, Kyo	P-046A	Yoshida, Masashi	P-017A
Wong, Elaine Y.M.	Yamada, Yasuhiro	Yamazaki, Masakazu		Yoshida, Michio	P-157A
OP03-04	FT03-09 (P075B)		FT06-15 (P104B)	"	P-174A
Wong, Hoi Leong Xavier	" P-027B	Yan, Yilin	P-124B	Yoshida, Naoki	FT04-01
FT04-02 (P137A)	Yamagaki, Tohru P-136B	Yanagi, Takanori		Yoshida, Shosei	OP06-10
Wong, Michael	Yamagata, Kazuo S03-05		SW1-06 (P173A)	"	FT05-09 (P008B)
WS2-10	" S03-06	Yang, Liu	S04-06	"	FT05-12 (P024B)
Wu, Chenxi	Yamaguchi, Takahiro	Yang, Yingzi	S04-06	"	FT05-15 (P004B)
OP03-09	FT02-02 (P178A)	Yang, Yun	S04-05	Yoshida-Noro, Chikako	
Wu, Chun-Shiu	Yamaguchi, Yasuka	Yao, Qing	P-140B		OP02-07
FT02-12 (P195B)	OP06-07	Yaoi, Yuichi		Yoshihara, Yoshihiro	
Wu, Hsiao-Huei	" P-138A		FT04-10 (P097A)		FT03-12 (P079B)
P-114A	Yamaguchi, Yoshifumi	Yasuda, Hidenori		Yoshii, Daiki	OP07-08
Wu, Jingyao	S03-01		FT06-08 (P123B)	Yoshimoto, Tasuku	
P-060B	Yamakami, Yukiko	Yasue, Akihiro	P-187B		SW2-03 (P154A)
Wu, Kan-Mai	P-196B	Yasugi, Sadao	P-106A	Yoshimura, Asami	
FT03-10 (P076B)	Yamakawa, Tomoko	Yasuoka, Yuuri	OP04-09		FT02-02 (P178A)
Wu, Quan	OP03-01	Yawo, Hiromu	P-072B	Yoshimura, Miho	
OP06-09	Yamamoto, Daisuke	Yazawa, Shigenobu			FT01-14 (P149A)
Wu, Xiaoming	P-157A		FT05-13 (P007B)	Yoshimura, Yuichi	
FT02-14 (P198A)					
Wynn, S.					
FT03-01 (P061A)					
X					
Xu, Luohao					
P-033A					
Xu, Minrui					
P-060B					
Xu, Qiling					
P-089A					
Xu, Shuhao					
P-124B					
Xu, Wenyan					

P-110A
Yu, Yuan-Ding
 FT03-08 (P074A)
Yuba, Shunsuke P-136B
 Z
Zaret, Kenneth WS2-05
Zhang, Fan
 FT01-08 (P172B)
Zhang, Guojie P-033A
Zhang, Shiping **OP03-08**
Zhang, Shuang S03-02
Zhang, Shuqing **P-060B**
Zhang, Yan S04-04
Zhang, Yanqing P-060B
Zhang, Zhao S04-02
Zhao, Wei
 FT06-01 (P048B)
Zhao, Yun **S04-02**
Zhao, Zhonghua S04-01
Zheng, Hongyu OP03-11
Zhong, Zhaomin **P-124B**
Zhou, Zhi
 FT05-01 (P030A)
Zhou, Zhongjun
 FT04-02 (P137A)
Zi, Wang P-106A

賛助企業（寄附、ランチョンセミナー、器機展示、広告）一覧

【寄附／Sponsors】

日本製薬団体連合会／The Federation of Pharmaceutical Manufacturers' Associations of JAPAN

The company of Biologists

公益財団法人 内藤記念科学振興財団／The Naito Foundation

公益財団法人 サントリー生命科学財団／Suntory Foundation for Life Sciences

ELSEVIER

【ランチョンセミナー／Luncheon Seminars】

オリンパス株式会社／Olympus Corporation

【器機展示／Exhibition】

ナカライテスク株式会社／NACALAI TESQUE, INC.

株式会社イワキ／IWAKI CO., LTD.

プライムテック株式会社／PRIME TECH Ltd.

ライフテクノロジーズジャパン株式会社／Life Technologies Japan Ltd.

株式会社ベックス／BEX CO., LTD.

中立電機株式会社／Churitsu Electric Corporation.

カールツァイスマイクロスコピー株式会社／Carl Zeiss Microscopy Co., Ltd.

株式会社医学生物学研究所／MEDICAL & BIOLOGICAL LABORATORIES CO., LTD.

株式会社 YOS／YOS Co., Ltd.

ライカマイクロシステムズ株式会社／Leica Microsystems K.K.

メディコー・コンインターナショナル株式会社／Medi-Con International Co., Ltd.

丸善出版株式会社／MARUZEN PUBLISHING CO., Ltd.

【広告／Advertisement】

株式会社羊土社／YODOSHA CO., LTD.

和研薬株式会社／WAKENYAKU CO., LTD.

株式会社医学生物学研究所／MEDICAL & BIOLOGICAL LABORATORIES CO., LTD.

株式会社キーエンス／KEYENCE CORPORATION

(2014年4月11日現在 順不同、敬称略)

MEMO

MEMO

MEMO

MEMO

MEMO



The Company of Biologists is a UK based charity and not-for-profit publisher run by biologists for biologists. The Company aims to promote research and study across all branches of biology through the publication of its five journals.

Development

Advances in developmental biology and stem cells dev.biologists.org

Journal of Cell Science

The science of cells jcs.biologists.org

The Journal of Experimental Biology

At the forefront of comparative physiology and integrative biology jeb.biologists.org

OPEN ACCESS

Disease Models & Mechanisms

Basic research with translational impact
dmm.biologists.org

Biology Open

Facilitating rapid peer review for accessible research bio.biologists.org

In addition to publishing, The Company makes an important contribution to the scientific community, providing grants, travelling fellowships and sponsorship to noteworthy scientists, meetings, societies and collaborative projects around the world. The Company also runs a series of transdisciplinary workshops.

For subscriptions and consortia sales email sales@biologists.com

Recommend a subscription by completing our library recommendation form
<http://biologists.com/downloads/Library.pdf>

For more information please visit our website biologists.com

Development

Journal of
Cell Science

The Journal of
Experimental
Biology

DMM Disease Models
& Mechanisms

Bio BIOLOGY
OPEN

THE COMPANY OF
Biologists

研究用途に
合わせた検索も
ラクラク!

和研薬の研究機器オンラインが、 リニューアル 検索しやすくなって新登場!!

予算申請の
金額に合わせた
検索もラクラク!



特長

- ▣ 予算申請に便利 → 金額範囲で検索が可能に!
- ▣ 研究用途から機器検索 → 細胞解析・有機合成・タンパク質解析などのカテゴリ検索
- ▣ あのメーカーのあの機器を → フリーワード検索やメーカー別索引も可能!
- ▣ 製品情報の充実 → 各製品の仕様表が詳細になりました!

和研薬の **NEW** 研究機器オンラインは、
PC、スマートフォンやタブレット端末からアクセス!

URL <http://www.wakenyaku.co.jp/ctg/>



和研薬 研究機器



技術と信頼でライフサイエンスの明日を担う
和研薬株式会社
WAKENYAKU CO., LTD.

本社営業部 〒606-8171 京都市左京区一乗寺西水干町17番地
TEL(075)721-8111/FAX(075)721-8189
京阪奈営業部 〒610-0343 京都府京田辺市大住池ノ端6番地5
TEL(0774)65-2521/FAX(0774)65-2557
滋賀営業部 〒525-0029 滋賀県草津市下笠町945番地1
TEL(077)568-2481/FAX(077)568-2410
神戸営業部 〒650-0047 兵庫県神戸市中央区港島南町5丁目2番5
TEL(078)306-6060/FAX(078)306-6070
大阪営業部 〒562-0035 大阪府箕面市船場東1丁目12-8
TEL(072)749-5200/FAX(072)749-5230

KEYENCE

従来の画像

ゼブラフィッシュ管轄

すべての研究者に、クリアな画像を

レーザーを使わずにワンクリックで「蛍光ボケ」を排除

従来の画像

ラット脳 神経細胞

暗室不要のオールインワン蛍光顕微鏡

NEW BZ-X700

大型電動ステージ内蔵で、あらゆる標本を素早く観察

暗室不要

筐体内にブラックスペースを内蔵。フル電動制御で、どこでもコントラストの高い蛍光観察が可能。

大型電動ステージ搭載

瞬時に視野合わせを行う「ステージビュー機能」で、あらゆる標本をスピーディに観察。スライドやディッシュの観察はもちろん、ウェルプレートの全面観察にも対応。

進化したタイムラプス

フォーカス追従機能搭載。視野を撮影途中で調整することもでき、もうターゲットを見逃すことはありません。

超高解像度画像連結

大量画像の自動定量機能

株式会社 キーエンス 本社・研究所/マイクロスコープ事業部

〒533-8555 大阪市東淀川区東中島1-3-14 Tel 06-6379-1141 Fax 06-6379-1140

頭機線

お客様相談窓口

0120-739-007

www.keymosp.jp

記載内容は、発売時点での弊社調べであり、予告なく変更する場合があります。

Copyright © 2013 KEYENCE CORPORATION. All rights reserved.

バイオサイエンスと医学の最先端総合誌

実験医学

月刊	毎月1日発行 B5判 定価(本体2,000円+税)
増刊	年8回発行 B5判 定価(本体5,400円+税)

本学会関連の特集テーマ

- 実験医学2014年4月号
生殖細胞 — 全能性を獲得し、世代を紡ぐサイクル 企画/斎藤通紀
- 実験医学2014年1月号
**再生できる・できない生物 その差から挑む
三次元再生と再生医療** 企画/田村宏治、阿形清和



増刊号も
好評販売中

年間購読は随時受付!

- 月刊のみ 24,000円 +税
 - 月刊+増刊 67,200円 +税
- ※ 海外からのご購読は送料実費となります

定期購読者向けサービス「**実験医学WEB特典β**」
実験医学を定期購読契約中のご購入者は、「月刊最新号」をWEBブラウザ上でご覧いただけます。
◆詳しくは www.yodosha.co.jp/ ⇒ 「雑誌定期購読」へ!

実験医学別冊

ES・iPS細胞 実験スタンダード

再生・創薬・疾患研究のプロトコールと臨床応用の必須知識

中辻憲夫/監 末盛博文/編

新刊

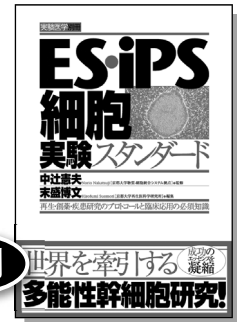

■ 定価 (本体 7,400円+税) ■ B5判 ■ 358頁 ■ ISBN 978-4-7581-0189-9

実験医学別冊 もっとよくわかる!シリーズ

もっとよくわかる! 幹細胞と 再生医療

長船健二/著

新刊



■ 定価 (本体 3,800円+税) ■ B5判 ■ 174頁 ■ ISBN 978-4-7581-2203-0

発行

羊土社
YODOSHA

〒101-0052 東京都千代田区神田小川町2-5-1 TEL 03(5282)1211 FAX 03(5282)1212
E-mail : eigy@yodosha.co.jp
URL : <https://www.yodosha.co.jp/>

ご注文は最寄りの書店、または小社営業部まで

HOW TO VIEW THE ONLINE ABSTRACT BOOK

47th annual meeting organizing committee

The online abstract book is only available for viewing for meeting participants and JSDB members.

Access the Meeting website

(<http://www.jsdb.jp/kaisai/jsdb2014/index-e.php>)

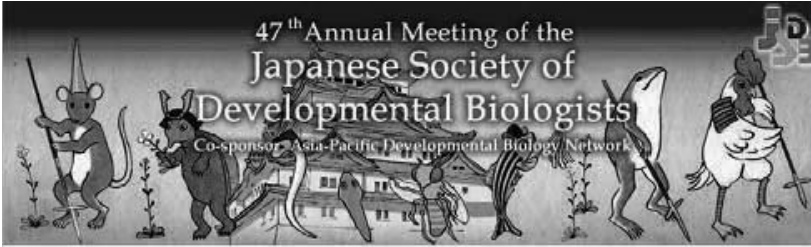

47th Annual Meeting of the
Japanese Society of
Developmental Biologists
Co-sponsor: Asia-Pacific Developmental Biology Network

HOME		Dates May 27(Tue) – May 30(Fri), 2014 <small>*May 27(Tue) Satellite Workshop (in Japanese)</small>
Information		Venue WINC AICHI (Nagoya, Aichi)
Schedule and Program		President Masahiko Hibi (Nagoya University)
Instruction for Presentations		Language May 27 (in Japanese and English) May 28-30 (in English)
Registration		
Sponsors and Exhibition		
About Nagoya		
Hotel Accommodation		
About Nursery		
JSDB Travel Fellowship and VISA		
Abstract Search		

To download the Poster, please click here.

Click on "Schedule and Program" from the menu bar on the left side of the page.

Click Here !
"Schedule and Program"

47th Annual Meeting of the Japanese Society of Developmental Biologists
Co-sponsor: Asia-Pacific Developmental Biology Network

HOME
Information
Schedule and Program
Instruction for Presentations
Registration
Sponsors and Exhibition
About Nagoya
Hotel Accommodation
About Nursery
JSDB Travel Fellowship and VISA
Abstract Search

47th Annual Meeting of the Japanese Society of Developmental Biologists
Co-sponsor: Asia-Pacific Developmental Biology Network

May 27 (Tue) – May 30 (Fri), 2014
*May 27(Tue) Satellite Workshop (in Japanese)

Venue: WING AICHI (Nagoya, Aichi)

President: Masahiko Hibi (Nagoya University)

Language: May 27 (in Japanese and English)
May 28-30 (in English)

To download the Poster, please click here.

Scroll through the program page and click on a program title of interest.

Title click !

Plenary Lectures

May 20 (Fri) 9:00-11:30 Room A
Plenary Lectures
Chairpersons: Tesuya Tabata (Univ. of Tokyo), Shiro Nakagawa (RIKEN)

PL-01: **Hedgehog Signaling in Development and Disease**
09:00-10:15 Matthew Scott (Stanford University, Center for Molecular and Cellular Biology)

PL-02: **The development of the hindbrain and zebrafish retinas**
10:15-11:30 William Harris (University of Cambridge)

[Go to top](#)

Symposia

DATE: May 19 (Thu) 9:00~11:30 Room A
Symposium1: Neural Development: from circuits to behavior

Edited by Organizing Committee of the 47th annual meeting of JSDB (2014)

URL: <http://www.jsdb.jp/kaisai/jsdb2014/>

E-mail: jsdb2014@jsdb.jp

Printed in Japan 2014 by Sasaki Printing & Publishing Co., Ltd.